

Simulink® 7

Getting Started Guide



MATLAB®
& **SIMULINK®**

How to Contact The MathWorks



www.mathworks.com Web
comp.soft-sys.matlab Newsgroup
www.mathworks.com/contact_TS.html Technical Support



suggest@mathworks.com Product enhancement suggestions
bugs@mathworks.com Bug reports
doc@mathworks.com Documentation error reports
service@mathworks.com Order status, license renewals, passcodes
info@mathworks.com Sales, pricing, and general information



508-647-7000 (Phone)



508-647-7001 (Fax)



The MathWorks, Inc.
3 Apple Hill Drive
Natick, MA 01760-2098

For contact information about worldwide offices, see the MathWorks Web site.

Simulink® Getting Started Guide

© COPYRIGHT 1990–2010 by The MathWorks, Inc.

The software described in this document is furnished under a license agreement. The software may be used or copied only under the terms of the license agreement. No part of this manual may be photocopied or reproduced in any form without prior written consent from The MathWorks, Inc.

FEDERAL ACQUISITION: This provision applies to all acquisitions of the Program and Documentation by, for, or through the federal government of the United States. By accepting delivery of the Program or Documentation, the government hereby agrees that this software or documentation qualifies as commercial computer software or commercial computer software documentation as such terms are used or defined in FAR 12.212, DFARS Part 227.72, and DFARS 252.227-7014. Accordingly, the terms and conditions of this Agreement and only those rights specified in this Agreement, shall pertain to and govern the use, modification, reproduction, release, performance, display, and disclosure of the Program and Documentation by the federal government (or other entity acquiring for or through the federal government) and shall supersede any conflicting contractual terms or conditions. If this License fails to meet the government's needs or is inconsistent in any respect with federal procurement law, the government agrees to return the Program and Documentation, unused, to The MathWorks, Inc.

Trademarks

MATLAB and Simulink are registered trademarks of The MathWorks, Inc. See www.mathworks.com/trademarks for a list of additional trademarks. Other product or brand names may be trademarks or registered trademarks of their respective holders.

Patents

The MathWorks products are protected by one or more U.S. patents. Please see www.mathworks.com/patents for more information.

Revision History

September 2005	Online only	New for Version 6.3 (Release 14SP3)
March 2006	Online only	Revised for Simulink® 6.4 (Release 2006a)
September 2006	Online only	Revised for Simulink® 6.5 (Release 2006b)
March 2007	First printing	Revised for Simulink® 6.6 (Release 2007a)
September 2007	Second printing	Revised for Simulink® 7.0 (Release 2007b)
March 2008	Third printing	Revised for Simulink® 7.1 (Release 2008a)
October 2008	Fourth printing	Revised for Simulink® 7.2 (Release 2008b)
March 2009	Fifth printing	Revised for Simulink® 7.3 (Release 2009a)
September 2009	Online only	Revised for Simulink® 7.4 (Release 2009b)
March 2010	Online only	Revised for Simulink® 7.5 (Release 2010a)

Introduction

1

Product Overview	1-2
Overview	1-2
Tool for Model-Based Design	1-3
Tool for Simulation	1-4
Tool for Analysis	1-4
How Simulink Software Interacts with the MATLAB Environment	1-4
What Is Model-Based Design?	1-5
Model-Based Design	1-5
Modeling Process	1-6
Related Products	1-9

Simulink Software Basics

2

Starting Simulink Software	2-2
Opening the Simulink Library Browser	2-2
Opening a Model	2-4
Simulink User Interface	2-6
Simulink Library Browser	2-6
Simulink Model Window	2-9
Getting Help with Simulink Software	2-10
Simulink Online Help	2-10
Simulink Demo Models	2-11
Web Site Resources	2-14

Creating a Simulink Model

3

Overview	3-2
Creating a Simple Model	3-3
Overview	3-3
Creating a New Model	3-3
Adding Blocks to Your Model	3-5
Moving Blocks in the Model Window	3-8
Connecting Blocks in the Model Window	3-9
Saving the Model	3-13
Simulating the Model	3-14
Overview	3-14
Setting Simulation Options	3-14
Running the Simulation and Observing Results	3-16

Modeling a Dynamic Control System

4

Overview	4-2
Understanding the Demo Model	4-3
Opening the Demo Model	4-3
Anatomy of the Demo Model	4-5
Using Subsystems	4-6
Masking Subsystems	4-9
Simulating the Model	4-11
Running the Simulation	4-11
Modifying Simulation Parameters	4-13
Importing Data from the MATLAB Workspace	4-20
Exporting Simulation Data to the MATLAB Workspace ..	4-25

Introduction

- “Product Overview” on page 1-2
- “What Is Model-Based Design?” on page 1-5
- “Related Products” on page 1-9

Product Overview

In this section...
“Overview” on page 1-2
“Tool for Model-Based Design” on page 1-3
“Tool for Simulation” on page 1-4
“Tool for Analysis” on page 1-4
“How Simulink Software Interacts with the MATLAB Environment” on page 1-4

Overview

Simulink® software models, simulates, and analyzes dynamic systems. It enables you to pose a question about a system, model the system, and see what happens.

With Simulink, you can easily build models from scratch, or modify existing models to meet your needs. Simulink supports linear and nonlinear systems, modeled in continuous time, sampled time, or a hybrid of the two. Systems can also be multirate — having different parts that are sampled or updated at different rates.

Thousands of scientists and engineers around the world use Simulink to model and solve real problems in a variety of industries, including:

- Aerospace and Defense
- Automotive
- Communications
- Electronics and Signal Processing
- Medical Instrumentation

Tool for Model-Based Design

With Simulink, you can move beyond idealized linear models to explore more realistic nonlinear models, factoring in friction, air resistance, gear slippage, hard stops, and the other things that describe real-world phenomena. Simulink turns your computer into a laboratory for modeling and analyzing systems that would not be possible or practical otherwise.

Whether you are interested in the behavior of an automotive clutch system, the flutter of an airplane wing, or the effect of the monetary supply on the economy, Simulink provides you with the tools to model and simulate almost any real-world problem. Simulink also provides demos that model a wide variety of real-world phenomena (see “Simulink Demo Models” on page 2-11).

Simulink provides a graphical user interface (GUI) for building models as block diagrams, allowing you to draw models as you would with pencil and paper. Simulink also includes a comprehensive block library of sinks, sources, linear and nonlinear components, and connectors. If these blocks do not meet your needs, however, you can also create your own blocks. The interactive graphical environment simplifies the modeling process, eliminating the need to formulate differential and difference equations in a language or program.

Models are hierarchical, so you can build models using both top-down and bottom-up approaches. You can view the system at a high level, then double-click blocks to see increasing levels of model detail. This approach provides insight into how a model is organized and how its parts interact.

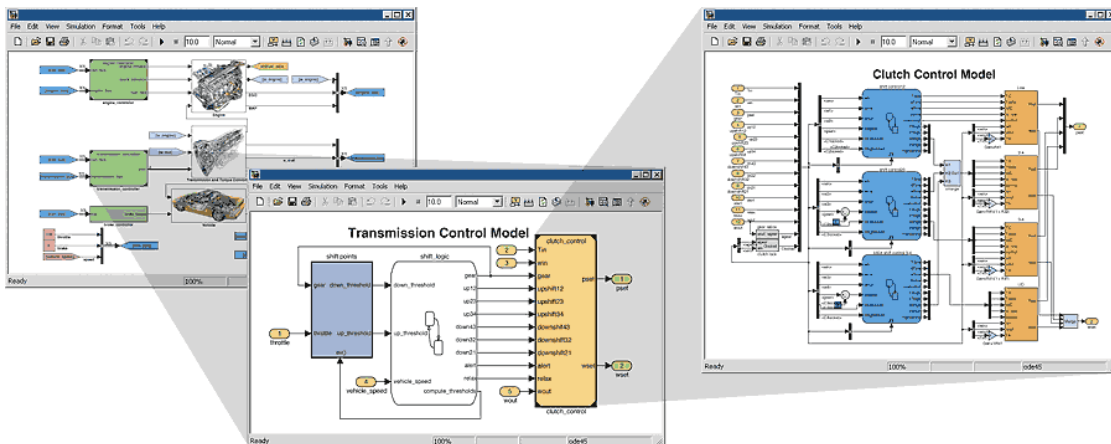

Tool for Simulation

After you define a model, you can simulate it, using a choice of mathematical integration methods, either from the Simulink menus or by entering commands in the MATLAB® Command Window. The menus are convenient for interactive work, while the command line is useful for running a batch of simulations (for example, if you are doing Monte Carlo simulations or want to apply a parameter across a range of values).

Using scopes and other display blocks, you can see the simulation results while the simulation runs. You can then change many parameters and see what happens for “what if” exploration. The simulation results can be put in the MATLAB workspace for postprocessing and visualization.

Tool for Analysis

Model analysis tools include linearization and trimming tools, which can be accessed from the MATLAB command line, plus the many tools in MATLAB and its application toolboxes. Because MATLAB and Simulink are integrated, you can simulate, analyze, and revise your models in either environment at any point.

How Simulink Software Interacts with the MATLAB Environment

Simulink software is tightly integrated with the MATLAB environment. It requires MATLAB to run, depending on it to define and evaluate model and block parameters. Simulink can also utilize many MATLAB features. For example, Simulink can use the MATLAB environment to:

- Define model inputs.
- Store model outputs for analysis and visualization.
- Perform functions within a model, through integrated calls to MATLAB operators and functions.

What Is Model-Based Design?

In this section...
“Model-Based Design” on page 1-5
“Modeling Process” on page 1-6

Model-Based Design

Model-Based Design is a process that enables faster, more cost-effective development of dynamic systems, including control systems, signal processing, and communications systems. In Model-Based Design, a system model is at the center of the development process, from requirements development, through design, implementation, and testing. The model is an executable specification that is continually refined throughout the development process. After model development, simulation shows whether the model works correctly.

When software and hardware implementation requirements are included, such as fixed-point and timing behavior, you can automatically generate code for embedded deployment and create test benches for system verification, saving time and avoiding the introduction of manually coded errors.

Model-Based Design allows you to improve efficiency by:

- Using a common design environment across project teams
- Linking designs directly to requirements
- Integrating testing with design to continuously identify and correct errors
- Refining algorithms through multidomain simulation
- Automatically generating embedded software code
- Developing and reusing test suites
- Automatically generating documentation
- Reusing designs to deploy systems across multiple processors and hardware targets

Modeling Process

There are six steps to modeling any system:

- 1** Defining the System
- 2** Identifying System Components
- 3** Modeling the System with Equations
- 4** Building the Simulink Block Diagram
- 5** Running the Simulation
- 6** Validating the Simulation Results

You perform the first three steps of this process outside of the Simulink software before you begin building your model.

Defining the System

The first step in modeling a dynamic system is to fully define the system. If you are modeling a large system that can be broken into parts, you should model each subcomponent on its own. Then, after building each component, you can integrate them into a complete model of the system.

For example, the demo model used later in this guide models the heating system of a house. This system can be broken down into three main parts:

- Heater subsystem
- Thermostat subsystem
- Thermodynamic model subsystem

The most effective way to build a model of this system is to consider each of these subsystems independently.

Identifying System Components

The second step in the modeling process is to identify the system components. Three types of components define a system:

- **Parameters** — System values that remain constant unless you change them
- **States** — Variables in the system that change over time
- **Signals** — Input and output values that change dynamically during the simulation

In Simulink, parameters and states are represented by blocks, while signals are represented by the lines that connect blocks.

For each subsystem that you identified, ask yourself the following questions:

- How many input signals does the subsystem have?
- How many output signals does the subsystem have?
- How many states (variables) does the subsystem have?
- What are the parameters (constants) in the subsystem?
- Are there any intermediate (internal) signals in the subsystem?

Once you have answered these questions, you should have a comprehensive list of the system components, and are ready to begin modeling the system.

Modeling the System with Equations

The third step in modeling a system is to formulate the mathematical equations that describe the system.

For each subsystem, use the list of system components you identified to describe the system mathematically. Your model may include:

- Algebraic equations
- Logical equations
- Differential equations, for continuous systems
- Difference equations, for discrete systems

You use these equations to create the block diagram in Simulink.

Building the Simulink Block Diagram

After you have defined the mathematical equations that describe each subsystem, you can begin building a block diagram of your model in Simulink.

Build the block diagram for each of your subcomponents separately. After you have modeled each subcomponent, you can then integrate them into a complete model of the system.

See “Creating a Simple Model” on page 3-3 for more information on building the block diagram.

Running the Simulation

After you build the Simulink block diagram, you can simulate the model and analyze the results.

Simulink allows you to interactively define system inputs, simulate the model, and observe changes in behavior. This allows you to quickly evaluate your model.

See “Simulating the Model” on page 3-14 for more information on running a simulation.

Validating the Simulation Results

Finally, you must validate that the model accurately represents the physical characteristics of the system.

You can use the linearization and trimming tools available from the MATLAB command line, plus the many tools in MATLAB and its application toolboxes to analyze and validate your model.

Related Products

The MathWorks™ provides many additional products that extend the capabilities of Simulink software. For information about these related products, see <http://www.mathworks.com/products/simulink/>.

Simulink Software Basics

- “Starting Simulink Software” on page 2-2
- “Simulink User Interface” on page 2-6
- “Getting Help with Simulink Software” on page 2-10

Starting Simulink Software

In this section...
“Opening the Simulink Library Browser” on page 2-2
“Opening a Model” on page 2-4

Opening the Simulink Library Browser

Your MATLAB environment must be running before you can open Simulink software. You start Simulink from within MATLAB.

To start Simulink and open the Simulink Library Browser:

- 1** Start MATLAB. For more information, see “Starting a MATLAB Session” in the *MATLAB Getting Started Guide*.
- 2** Enter `simulink` in the MATLAB Command Window.

The Simulink Library Browser opens.

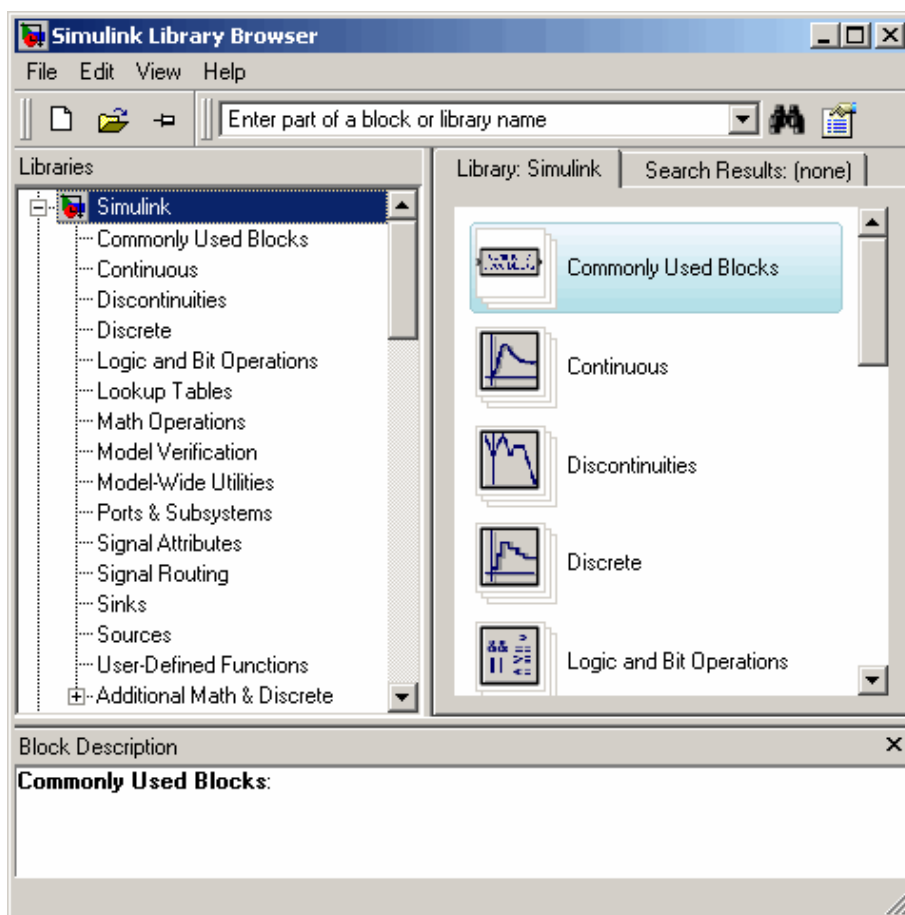

Note You can also start Simulink by:

- Clicking the Simulink icon  in the MATLAB toolbar
- Clicking the MATLAB **Start** button, then selecting **Simulink > Library Browser**

Opening a Model

You can open existing Simulink models or create new models from the Simulink Library Browser.

To create a new model:

- Select **File > New > Model** in the Simulink Library Browser.

The software opens an empty model window.

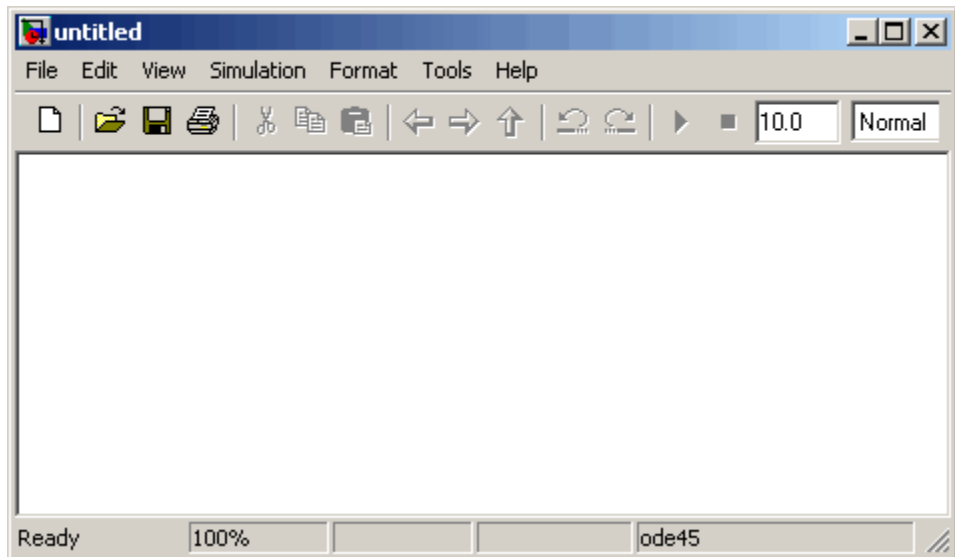

To open an existing model:

- 1 Select **File > Open** in the Simulink Library Browser.

The Open dialog box appears.

- 2 Select the model (.mdl file) you want to open, then click **Open**.

The software opens the selected model in the model window.

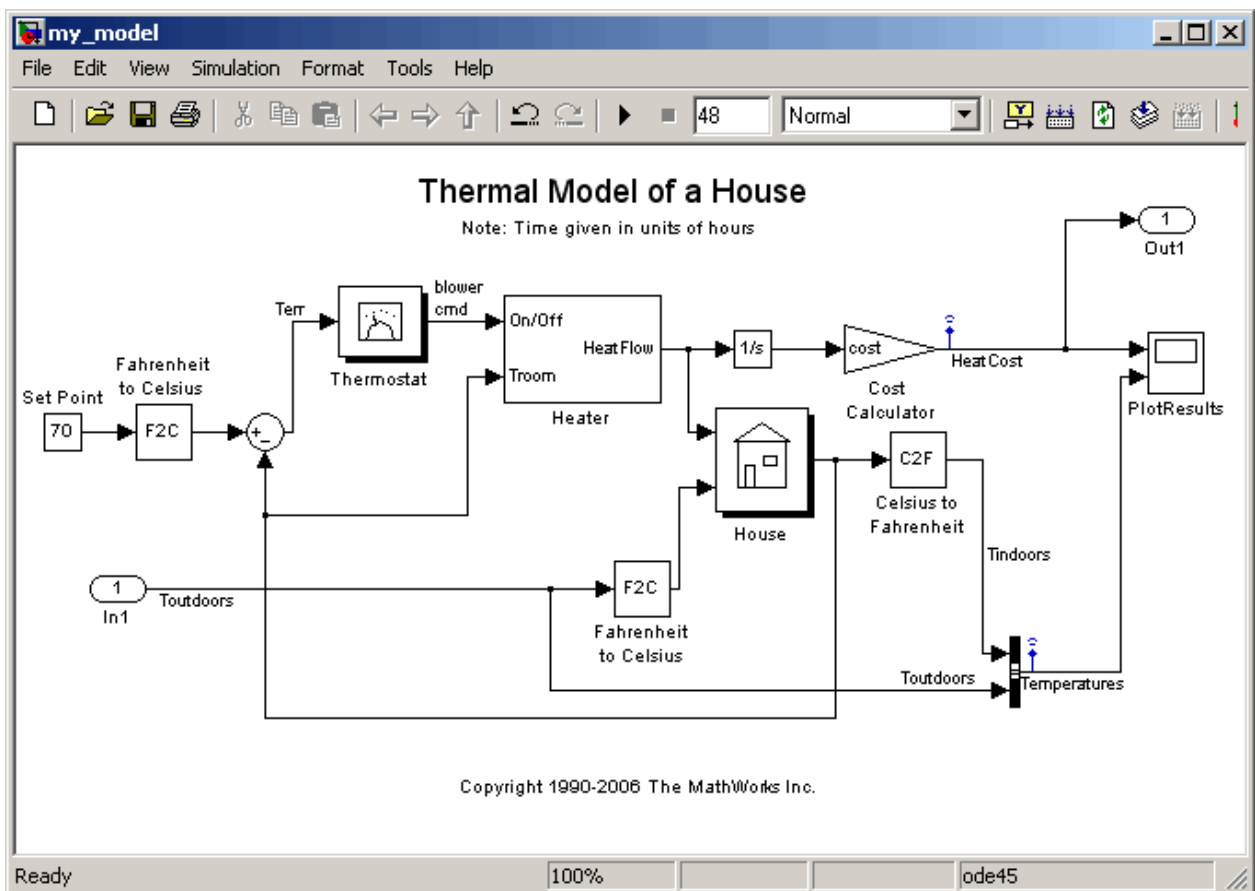

Simulink User Interface

In this section...
“Simulink Library Browser” on page 2-6
“Simulink Model Window” on page 2-9

Simulink Library Browser

The Library Browser displays the Simulink block libraries installed on your system. You build models by copying blocks from a library into a model window.

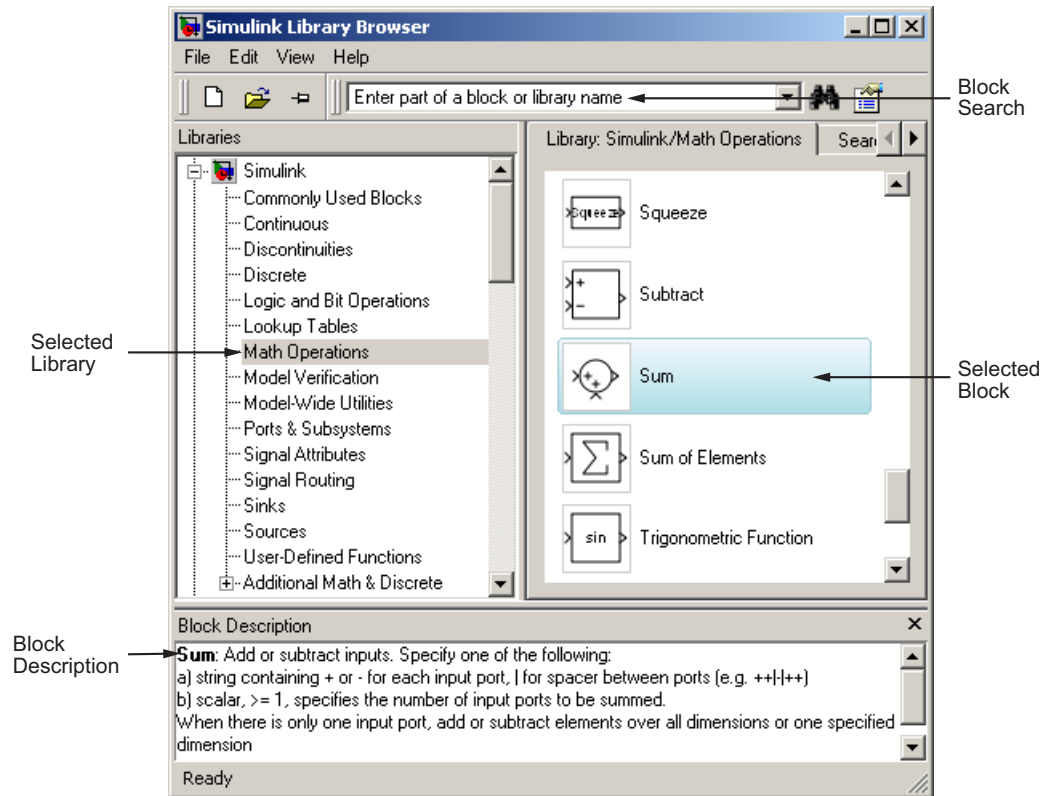

Simulink® Library Browser

Tips for Using the Library Browser

When using the Library Browser, note the following:

- You can view the blocks in a library by selecting the library name on the left side of the Library Browser, or by double-clicking the library.
- When you select a block, a description of that block appears at the bottom of the browser.
- For more information on a block, select the block, then select **Help > Help on the Selected Block** to display the help page for the block.
- You can view the parameters for a block by right-clicking the block, then selecting **Block Parameters**.
- You can search for a specific block by entering the name of the block in the block search field, then clicking the Find block icon .

Standard Block Libraries

Simulink software provides 16 standard block libraries. The following table describes each of these libraries.

Block Library	Description
Commonly Used Blocks	Contains a group of the most commonly used blocks, such as the Constant , In1 , Out1 , Scope , and Sum blocks. Each of the blocks in this library are also included in other libraries.
Continuous	Contains blocks that model linear functions, such as the Derivative and Integrator blocks.
Discontinuities	Contains blocks with outputs that are discontinuous functions of their inputs, such as the Saturation block.
Discrete	Contains blocks that represent discrete time functions, such as the Unit Delay block.
Logic and Bit Operations	Contains blocks that perform logic or bit operations, such as the Logical Operator and Relational Operator blocks.

Block Library	Description
LookUp Tables	Contains blocks that use lookup tables to determine their outputs from their inputs, such as the Cosine and Sine blocks.
Math Operations	Contains blocks that perform mathematical and logical functions, such as the Gain , Product , and Sum blocks.
Model Verification	Contains blocks that enable you to create self-validating models, such as the Check Input Resolution block.
Model-Wide Utilities	Contains blocks that provide information about the model, such as the Model Info block.
Ports & Subsystems	Contains blocks that allow you to create subsystems, such as the In1 , Out1 , and Subsystem blocks.
Signal Attributes	Contains blocks that modify the attributes of signals, such as the Data Type Conversion block.
Signal Routing	Contains blocks that route signals from one point in a block diagram to another, such as the Mux and Switch blocks.
Sinks	Contains blocks that display or export output, such as the Out1 and Scope blocks.
Sources	Contains blocks that generate or import system inputs, such as the Constant , In1 , and Sine Wave blocks.
User-Defined Functions	Contains blocks that allow you to define custom functions, such as the Embedded MATLAB® Function block.
Additional Math & Discrete	Contains two additional libraries for mathematical and discrete function blocks.

Simulink Model Window

The model window contains the block diagram of the model. You build models in the model window by arranging blocks logically, setting the parameters for each block, and then connecting the blocks with signal lines.

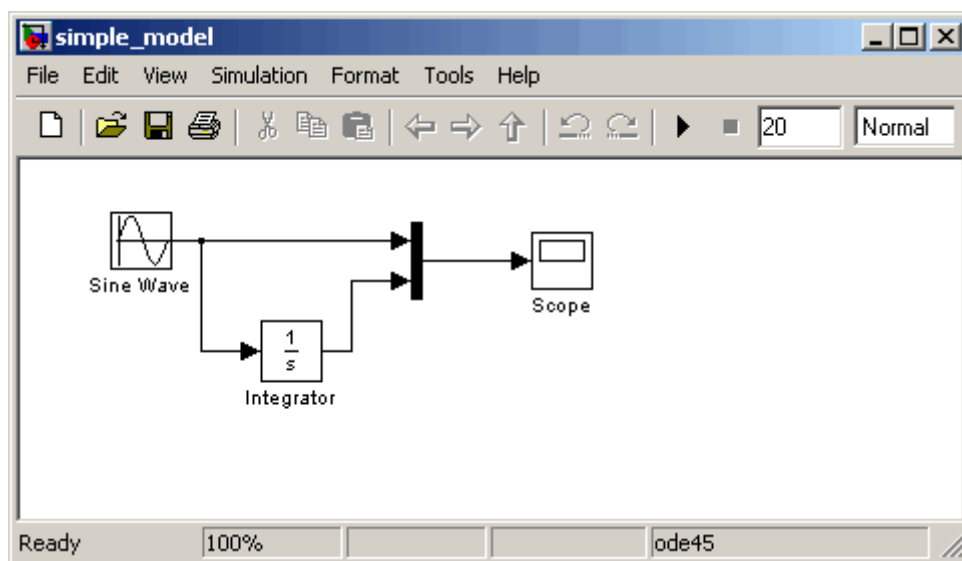

The model window also allows you to:

- Set configuration parameters for the model, including the start and stop time, type of solver to use, and data import/export settings.
- Start and stop simulation of the model.
- Save the model.
- Print the block diagram.

Getting Help with Simulink Software

In this section...
“Simulink Online Help” on page 2-10
“Simulink Demo Models” on page 2-11
“Web Site Resources” on page 2-14

Simulink Online Help

Simulink software provides comprehensive online help that describes Simulink features, blocks, and functions, and provides detailed procedures for common tasks. The help includes online versions of all Simulink documentation, including:

- *Simulink Getting Started Guide* (this guide)
- *Simulink User’s Guide*
- *Simulink Reference*
- *Writing S-Functions*
- *Simulink Release Notes*

You access the online help from the **Help** menu of the Simulink Library Browser or model window.

To access the online help:

- From the Simulink Library Browser, select **Help > Simulink Help**.
- From the Simulink model window, select **Help > Using Simulink**.

Note To quickly access the help page for a specific block, right-click the block and select **Help**.

Simulink Demo Models

Simulink software provides a variety of demo models that illustrate key modeling concepts and Simulink features. You can access these demos from the MATLAB Command Window.

To access Simulink demos:

- 1** On the bottom left corner of the MATLAB Command Window, click the **Start** button.

The **Start** menu appears.

- 2** Select **Simulink > Demos** from the Start menu.

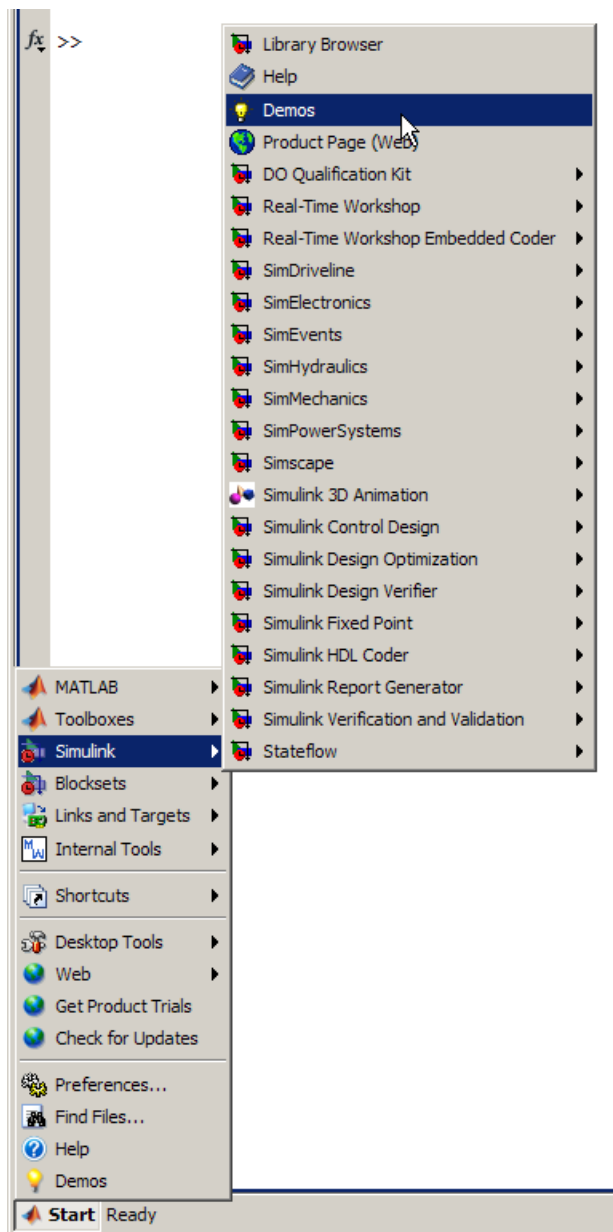

- 3** From the Simulink demos page in the MATLAB Help browser, click the demo model you want to open.

Web Site Resources

You can access additional Simulink resources on the MathWorks™ Web site, including Simulink related books, prerecorded webinars, and technical support.

To access the Simulink product page, go to:

<http://www.mathworks.com/products/simulink>

Creating a Simulink Model

- “Overview” on page 3-2
- “Creating a Simple Model” on page 3-3
- “Simulating the Model” on page 3-14

Overview

This chapter describes how to create a simple model using Simulink software, and how to simulate that model. The basic techniques you use to create and simulate this simple model are the same as those for more complex models.

The model described in this chapter integrates a sine wave and displays the result along with the original wave. When completed, the block diagram of the model should look similar to this:

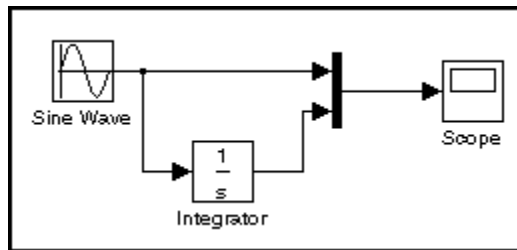

The instructions for constructing and simulating the example model are brief. However, each task is described in more detail in *Simulink User's Guide*.

Creating a Simple Model

In this section...

“Overview” on page 3-3

“Creating a New Model” on page 3-3

“Adding Blocks to Your Model” on page 3-5

“Moving Blocks in the Model Window” on page 3-8

“Connecting Blocks in the Model Window” on page 3-9

“Saving the Model” on page 3-13

Overview

This section describes how to model a simple dynamic system using Simulink software. After you create the model, you can simulate it as described in “Simulating the Model” on page 3-14.

Creating a New Model

Before you can begin building your model, you must start Simulink and create an empty model.

To create a new model:

- 1** If Simulink is not running, enter `simulink` in the MATLAB Command Window to open the Simulink Library Browser.
- 2** Select **File > New > Model** in the Simulink Library Browser to create a new model.

The software opens an empty model window.

3 Creating a Simulink® Model

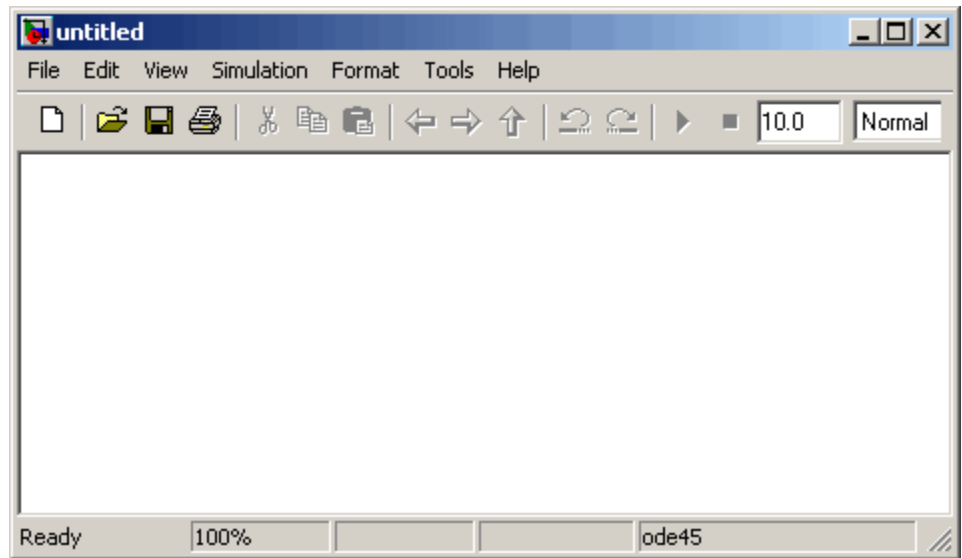

Adding Blocks to Your Model

To construct a model, you first copy blocks from the Simulink Library Browser to the model window. To create the simple model in this chapter, you need four blocks:

- **Sine Wave** — To generate an input signal for the model
- **Integrator** — To process the input signal
- **Scope** — To visualize the signals in the model
- **Mux** — To multiplex the input signal and processed signal into a single scope

To add blocks to your model:

- 1 Select the **Sources** library in the Simulink Library Browser.

The Simulink Library Browser displays the Sources library.

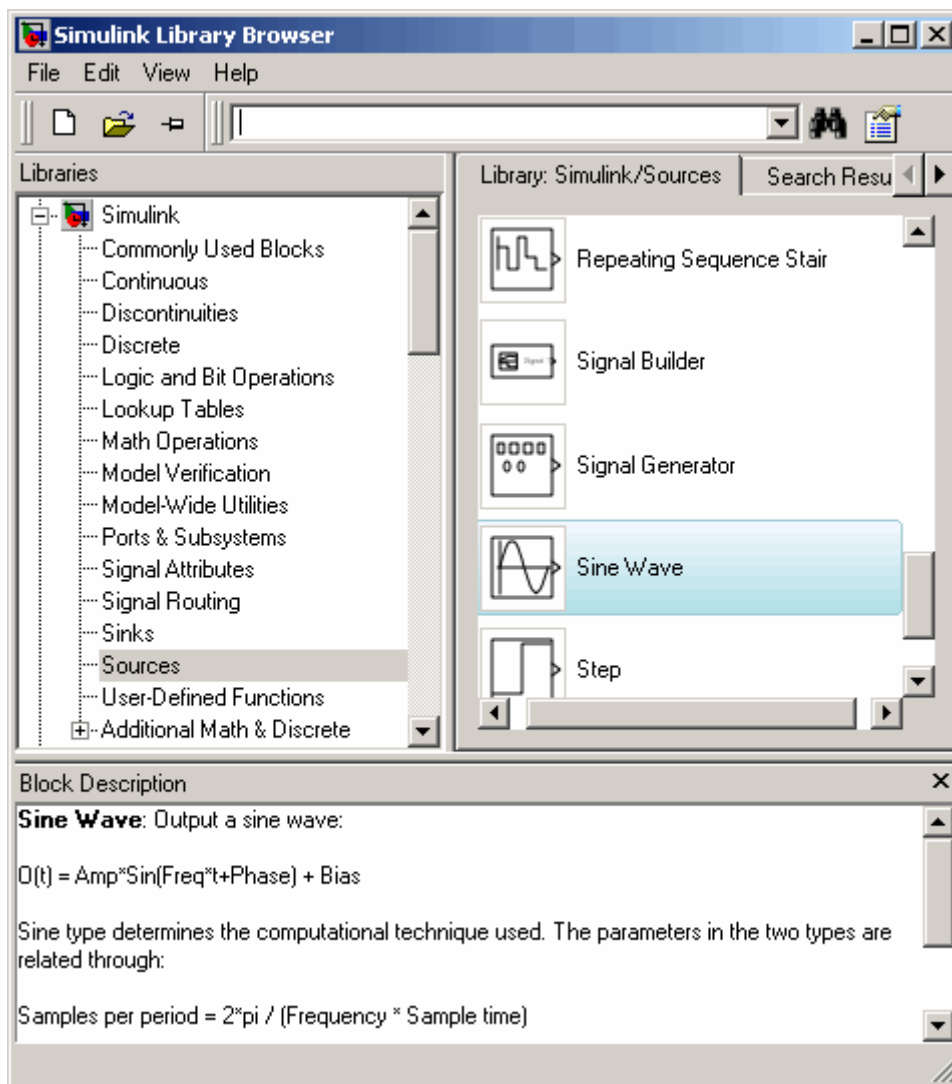

- 2 Select the **Sine Wave** block in the Simulink Library Browser, then drag it to the model window.

A copy of the Sine Wave block appears in the model window.

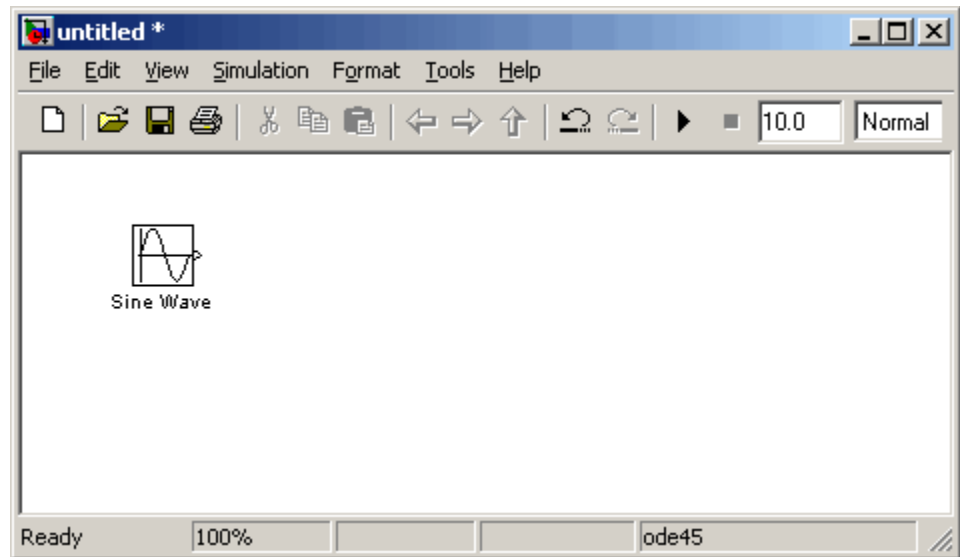

- 3** Select the **Sinks** library in the Simulink Library Browser.
- 4** Select the **Scope** block from the Sinks library, then drag it to the model window.
A Scope block appears in the model window.
- 5** Select the **Continuous** library in the Simulink Library Browser.
- 6** Select the **Integrator** block from the Continuous library, then drag it to the model window.
An Integrator block appears in the model window.
- 7** Select the **Signal Routing** library in the Simulink Library Browser.
- 8** Select the **Mux** block from the Sinks library, then drag it to the model window.
A Mux block appears in the model window.

Moving Blocks in the Model Window

Before you connect the blocks in your model, you should arrange them logically to make the signal connections as straightforward as possible.

To move a block in the model window, you can either:

- Drag the block.
- Select the block, then press the arrow keys on the keyboard.

Arrange the blocks in the model to look like the following figure.

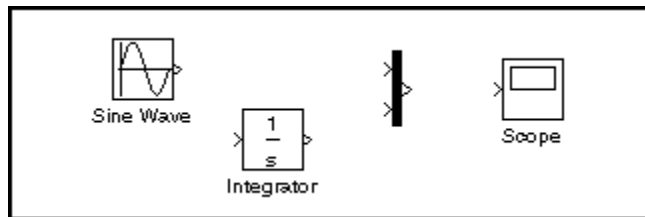

Connecting Blocks in the Model Window

After you add blocks to the model window, you must connect them to represent the signal connections within the model.

Notice that each block has angle brackets on one or both sides. These angle brackets represent input and output ports:

- The > symbol pointing into a block is an *input port*.
- The > symbol pointing out of a block is an *output port*.

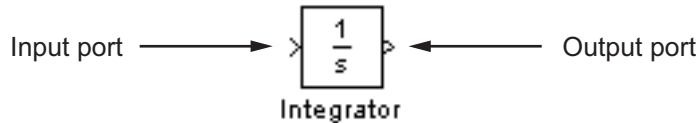

The following sections describe how to connect blocks by drawing lines from output ports to input ports:

- “Drawing Lines Between Blocks” on page 3-9
- “Drawing a Branch Line” on page 3-11

Drawing Lines Between Blocks

You connect the blocks in your model by drawing lines between output ports and input ports.

To draw a line between two blocks:

- 1 Position the mouse pointer over the output port on the right side of the Sine Wave block.

Note that the pointer changes to a cross hairs (+) shape while over the port.

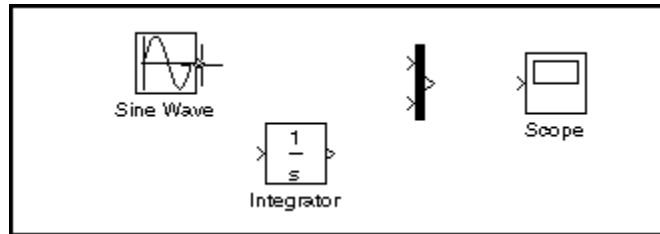

- 2 Drag a line from the output port to the top input port of the Mux block.

Note that the line is dashed while you hold the mouse button down, and that the pointer changes to a double-lined cross hairs as it approaches the input port of the Mux block.

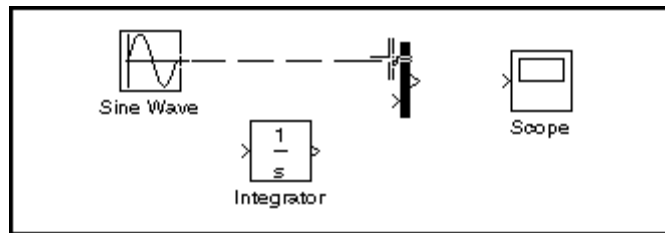

- 3 Release the mouse button over the output port.

The software connects the blocks with an arrow that indicates the direction of signal flow.

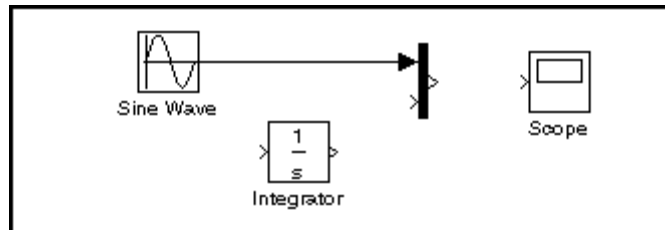

- 4 Drag a line from the output port of the Integrator block to the bottom input port on the Mux block.

The software connects the blocks.

- 5 Select the Mux block, then Ctrl+click the Scope block.

The software automatically draws the connection line between the blocks.

Note The Ctrl+click shortcut is especially useful when you are connecting widely separated blocks, or when working with complex models.

The model should now look similar to the following figure.

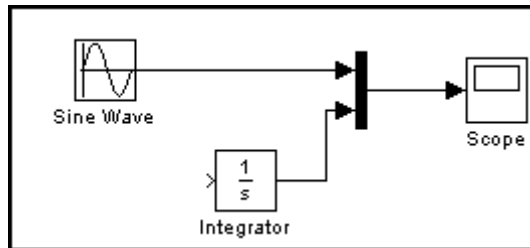

Drawing a Branch Line

The model is almost complete, but one connection is missing. To finish the model, you must connect the Sine Wave block to the Integrator block.

This final connection is somewhat different from the other three, which all connect output ports to input ports. Because the output port of the Sine Wave block already has a connection, you must connect this existing line to the input port of the Integrator block. The new line, called a *branch line*, carries the same signal that passes from the Sine Wave block to the Mux block.

To weld a connection to an existing line:

- 1 Position the mouse pointer *on the line* between the Sine Wave and the Mux block.

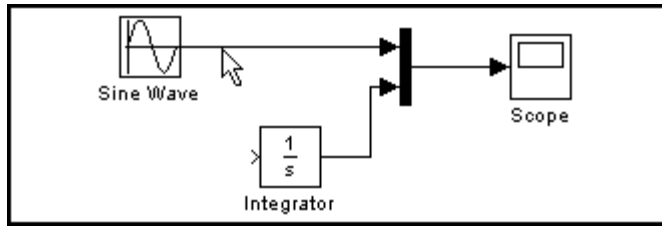

- 2** Press and hold the **Ctrl** key, then drag a line to the Integrator block's input port.

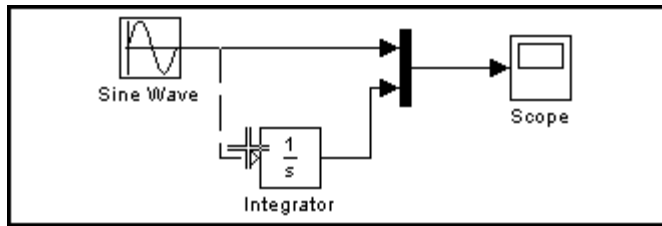

The software draws a line between the starting point and the input port of the Integrator block.

The model is now complete. It should look similar to the following figure.

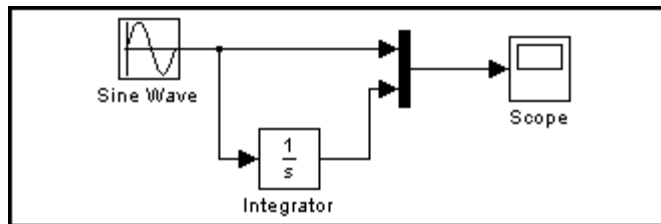

Saving the Model

After you complete the model, you should save it for future use.

To save the model:

- 1** Select **File > Save** in the model window.
- 2** Specify the location in which you want to save the model.
- 3** Enter `simple_model` in the **File name** field.
- 4** Click **Save**.

The software saves the model with the file name `simple_model.mdl`.

Simulating the Model

In this section...
“Overview” on page 3-14
“Setting Simulation Options” on page 3-14
“Running the Simulation and Observing Results” on page 3-16

Overview

After you complete the model, you can simulate it and visualize the results. This section describes how to simulate the sample model you created in the previous section, “Creating a Simple Model” on page 3-3.

Setting Simulation Options

Before simulating a model, you can set simulation options such as the start and stop time, and the type of solver that Simulink software uses to solve the model at each time step. You specify these options using the Configuration Parameters dialog box.

To specify simulation options for the sample model:

- 1 Select **Simulation > Configuration Parameters** in the model window.

The software displays the Configuration Parameters dialog box.

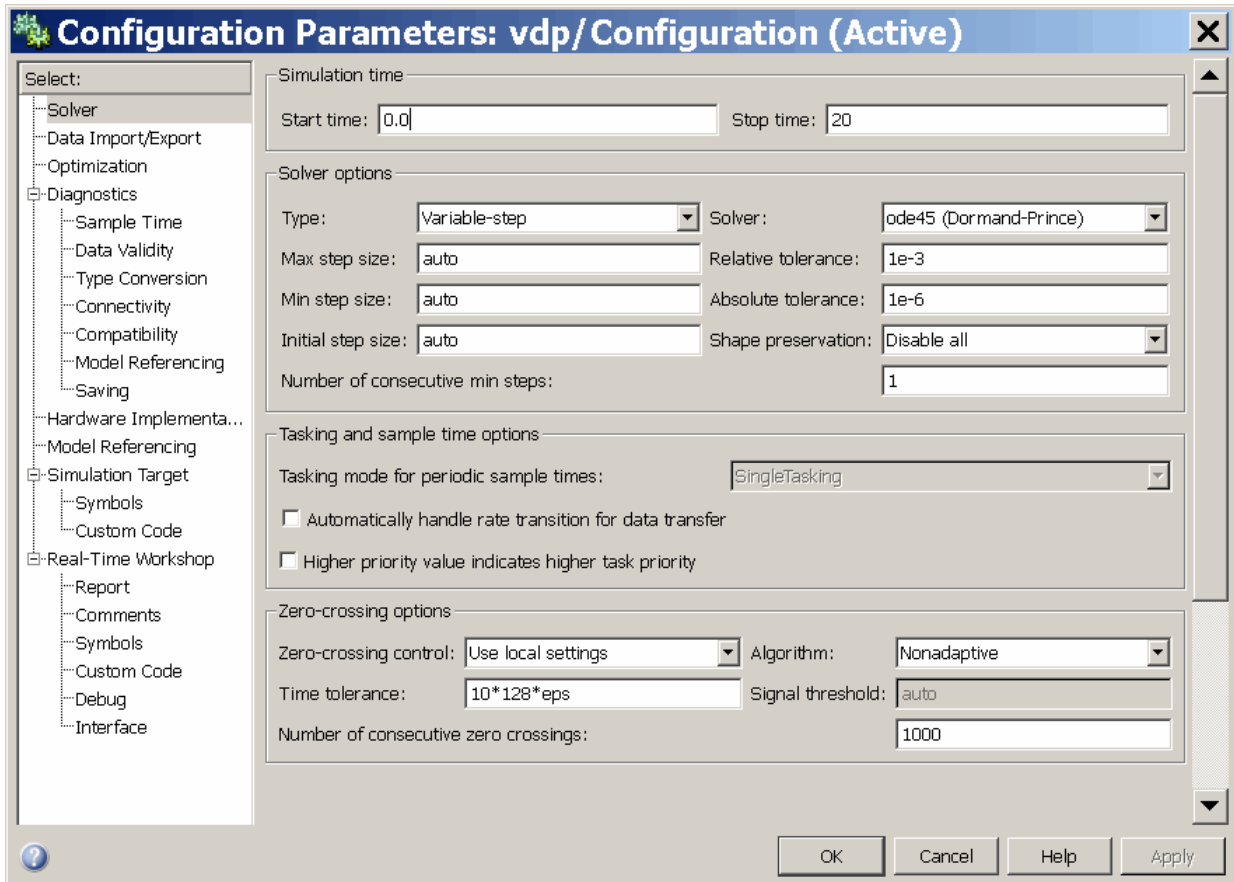

2 Enter 20 in the **Stop time** field.

3 Click **OK**.

The software applies your changes to the parameters and closes the Configuration Parameters dialog box.

Note For more information on Simulink configuration parameters, see “Configuration Parameters Dialog Box” in the Simulink online documentation.



Running the Simulation and Observing Results

Now you are ready to simulate your example model and observe the simulation results.

To run the simulation:

- 1 Select **Simulation > Start** in the model window.

The software runs the model, stopping when it reaches the stop time specified in the Configuration Parameters dialog box.

Tip On computers running the Microsoft® Windows® operating system, you can click the **Start simulation** button  and **Stop simulation** button  in the model window toolbar to start and stop a simulation.

- 2 Double-click the **Scope** block in the model window.

The Scope window displays the simulation results.

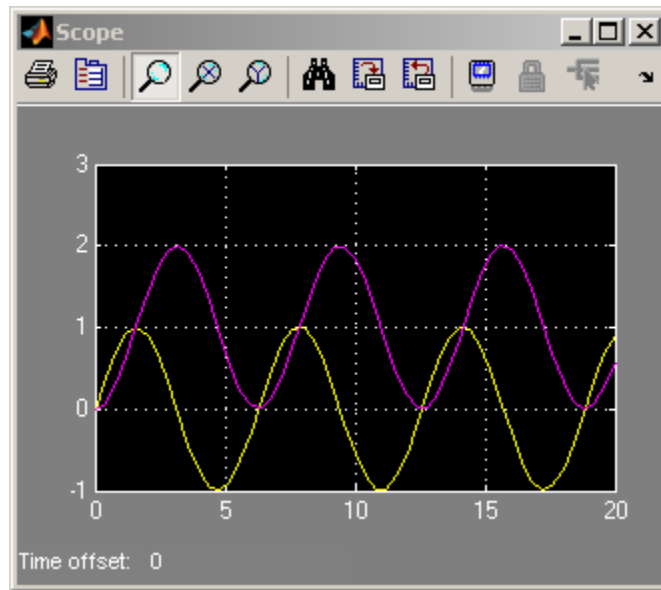

3 Select **File > Save** in the model window.

The software saves the model.

4 Select **File > Close** in the model window.

The software closes the model.

Modeling a Dynamic Control System

- “Overview” on page 4-2
- “Understanding the Demo Model” on page 4-3
- “Simulating the Model” on page 4-11

Overview

This chapter illustrates how Simulink software can model a dynamic control system, using an example that simulates the thermodynamics of a house. The system models the outdoor environment, the thermal characteristics of the house, and the house heating system.

This chapter allows you to explore common Simulink modeling tasks, including:

- Grouping multiple blocks in a model into a single *subsystem*, simplifying the block diagram
- Customizing the appearance of blocks using the masking feature
- Simulating a model and observing the results using a Scope block
- Changing the input parameters of the model to investigate how the system responds
- Importing data from the MATLAB workspace into a model before simulation
- Exporting simulation data from the model back to the MATLAB workspace

Understanding the Demo Model

In this section...

“Opening the Demo Model” on page 4-3

“Anatomy of the Demo Model” on page 4-5

“Using Subsystems” on page 4-6

“Masking Subsystems” on page 4-9

Opening the Demo Model

The demo model described in this chapter is called `sldemo_househeat`. You can open it from the MATLAB Command Window.

To open the demo model:

- 1 Ensure that MATLAB is open.
- 2 Enter `sldemo_househeat` in the MATLAB Command Window.

The software starts and opens the `sldemo_househeat` model.

4 Modeling a Dynamic Control System

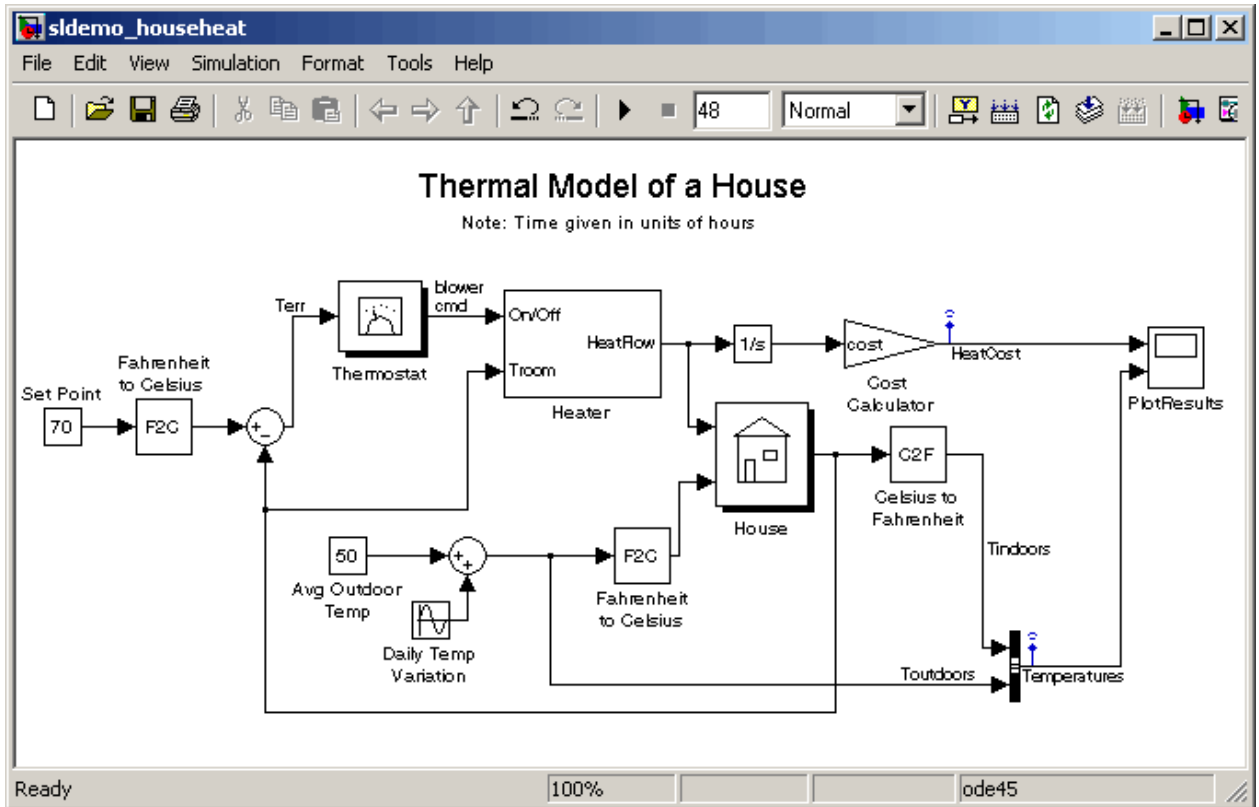

Anatomy of the Demo Model

The demo system models the outdoor environment, the thermal characteristics of the house, and the house heating system. It allows you to simulate how the thermostat setting and outdoor environment affect the indoor temperature and cumulative heating costs.

The demo model includes many of the same blocks you used to create the simple model in Chapter 3, “Creating a Simulink Model”. These include:

- A *Scope block* (labeled `PlotResults`) on the far right displays the simulation results.
- A *Mux block* at the bottom right combines the indoor and outdoor temperature signals for the Scope.
- A *Sine Wave block* (labeled `Daily Temp Variation`) at the bottom left provides one of three data sources for the model.

In the demo, the thermostat is set to 70 degrees Fahrenheit. The system models fluctuations in outdoor temperature by applying a sine wave with amplitude of 15 degrees to a base temperature of 50 degrees.

The three data inputs (sources) are provided by two Constant blocks (labeled `Set Point` and `Avg Outdoor Temp`), and the Sine Wave block (labeled `Daily Temp Variation`). The Scope block labeled `PlotResults` is the one output (sink).

Using Subsystems

The `sldemo_househeat` demo model uses *subsystems* to simplify the appearance of the block diagram, create reusable components, and customize the appearance of blocks. A subsystem is a hierarchical grouping of blocks encapsulated by a single Subsystem block.

The demo model uses the following subsystems:

- Thermostat
- Heater
- House
- Fahrenheit to Celsius
- Celsius to Fahrenheit

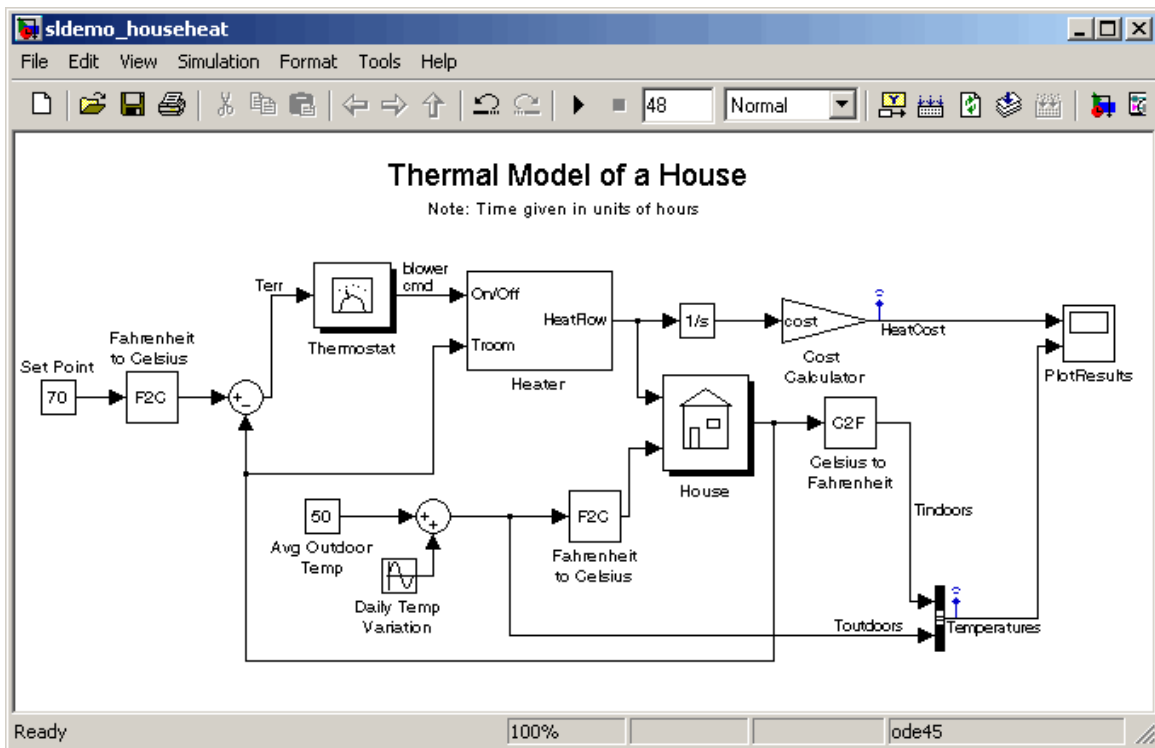

Subsystems can be complex and contain many blocks that might otherwise clutter a diagram. For example, double-click the House subsystem to open it.

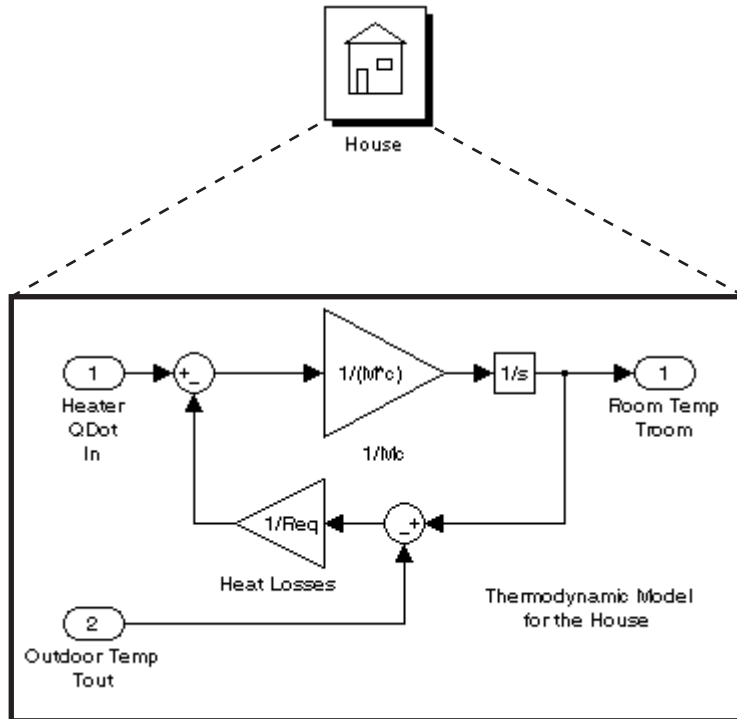

Contents of House subsystem

You can see that the subsystem receives heat flow and external temperature as inputs, which it uses to compute the current room temperature. You could leave each of these blocks in the main model window, but combining them as a subsystem helps simplify the block diagram.

Subsystems can also be simple and contain only a few blocks. For example, double-click the Thermostat subsystem to open it.

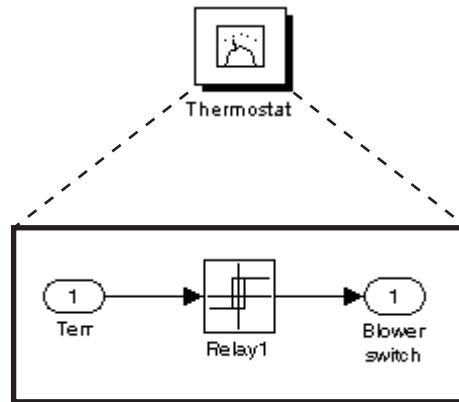

Contents of Thermostat subsystem

This subsystem models the operation of a thermostat, determining when the heating system is on or off. It contains only one Relay block, but logically represents the thermostat in the block diagram.

Subsystems are also reusable, enabling you to implement an algorithm once and use it multiple times. For example, the model contains two instances of identical subsystems named *Fahrenheit to Celsius*. These subsystems convert the inside and outside temperatures from degrees Fahrenheit to degrees Celsius.

Creating a Subsystem

Creating a subsystem allows you to group multiple related blocks into one subsystem block.

To create a subsystem:

- 1 Select the Thermostat block in the demo model.
- 2 Shift-click the Heater block in the demo model to select it.
- 3 Select **Edit > Create Subsystem** in the model window.

The software creates a Subsystem block containing the Thermostat and Heater blocks.

- 4 Select **Edit > Undo Create Subsystem** to return the model to its original configuration.

For more information about working with subsystems, see “Creating Subsystems” in the Simulink User’s Guide.

Masking Subsystems

You can customize the appearance of a subsystem by using a process known as *masking*. Masking a subsystem allows you to specify a unique icon and dialog box for the Subsystem block. For example, the House and Thermostat subsystems display custom icons that depict physical objects, while the conversion subsystems display custom dialog boxes when you double-click them.

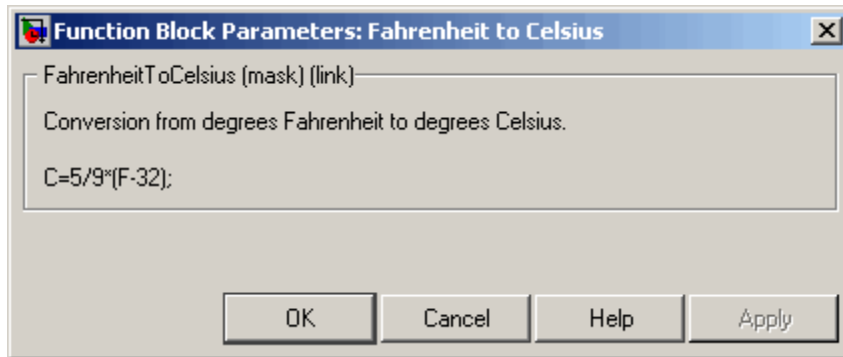

To view the underlying blocks in the conversion subsystem, right-click the subsystem block, then select **Look Under Mask**.

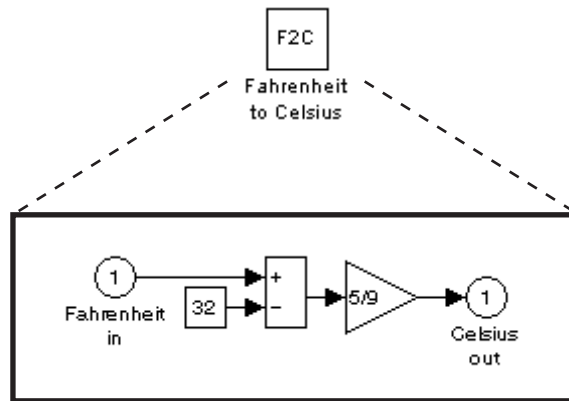

Contents of Fahrenheit to Celsius subsystem

Creating a Subsystem Mask

To mask a subsystem:

- 1 Select the Heater block in the demo model.
- 2 Select **Edit > Mask Subsystem** in the model window.
The Mask Editor dialog box appears.
- 3 Select **disp (show text in center of block)** in the Command drop-down menu.
- 4 Enter `disp('HEATER')` in the **Drawing commands** field.
- 5 Click **OK**.

The software masks the subsystem block with the text you entered.

For more information about masking subsystems, see “Working with Block Masks” in the Simulink User’s Guide.

Simulating the Model

In this section...

“Running the Simulation” on page 4-11

“Modifying Simulation Parameters” on page 4-13

“Importing Data from the MATLAB Workspace” on page 4-20

“Exporting Simulation Data to the MATLAB Workspace” on page 4-25

Running the Simulation

Simulating the model allows you to observe how the thermostat setting and outdoor environment affect the indoor temperature and the cumulative heating cost.

To run the simulation:

- 1 In the demo model window, double-click the Scope block named `PlotResults`.

The software opens a Scope window that contains two axes with the labels “HeatCost” and “Temperatures.”

- 2 Select **Simulation > Start** in the model window.

The software simulates the model. As the simulation runs, the cumulative heating cost appears on the “HeatCost” graph at the top of the Scope window. The indoor and outdoor temperatures appear on the “Temperatures” graph as yellow (top) and magenta (bottom) signals, respectively.

4 Modeling a Dynamic Control System

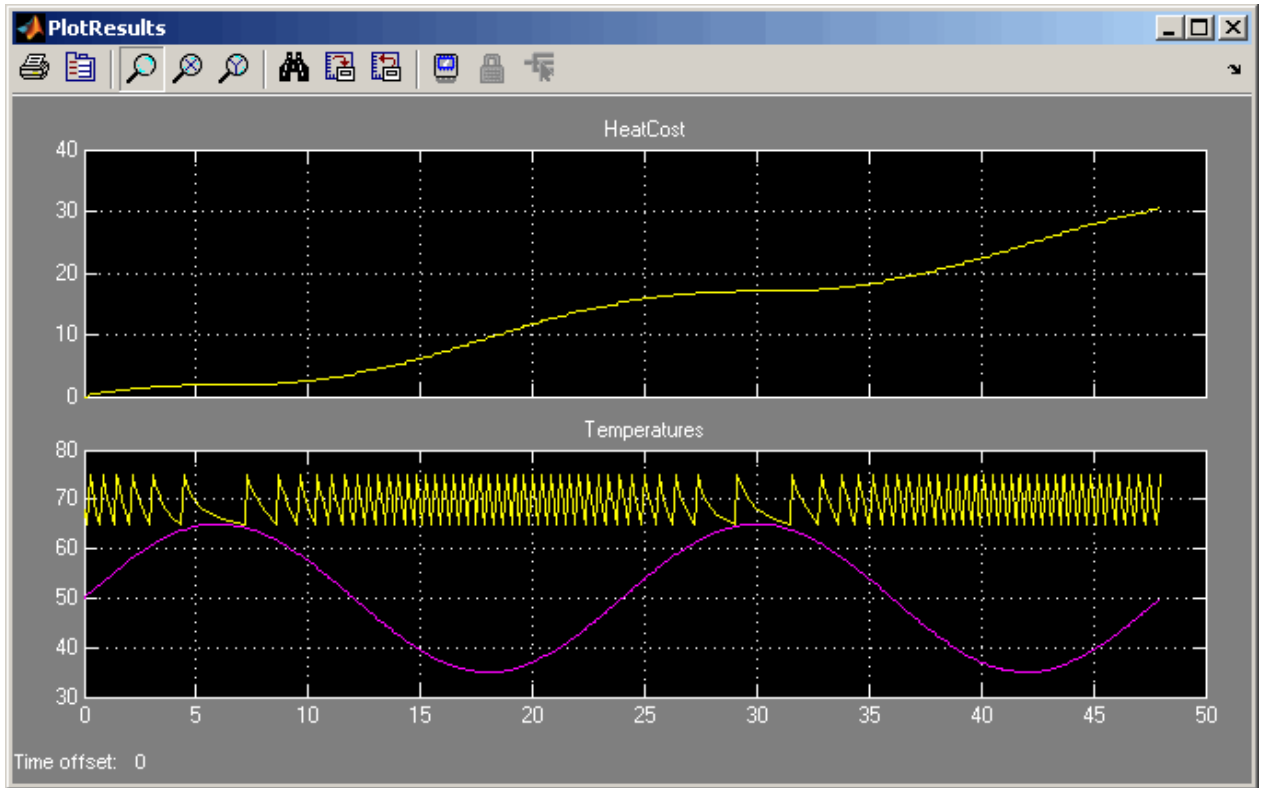

Modifying Simulation Parameters

One of the most powerful benefits of modeling a system with Simulink is the ability to interactively define the system inputs and observe changes in the behavior of your model. This allows you to quickly evaluate your model and validate the simulation results. This section describes:

- “Changing the Thermostat Setting” on page 4-13
- “Changing the Average Outdoor Temperature” on page 4-16
- “Changing the Daily Temperature Variation” on page 4-18

Changing the Thermostat Setting

Change the thermostat setting to 68 degrees Fahrenheit and observe how the model responds.

To change the thermostat setting:

- 1 Double-click the Set Point block in the model window.

The Source Block Parameters dialog box appears.

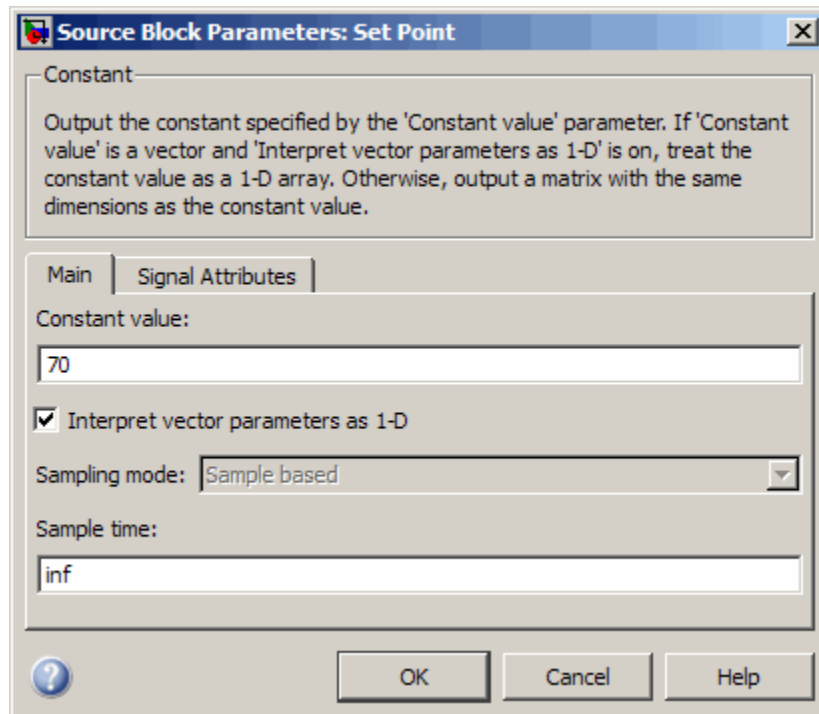

2 Enter 68 in the **Constant value** field.

3 Click **OK**.

The software applies your changes.

4 Select **Simulation > Start** to rerun the simulation.

The software simulates the model.

Notice that a lower thermostat setting reduces the cumulative heating cost.

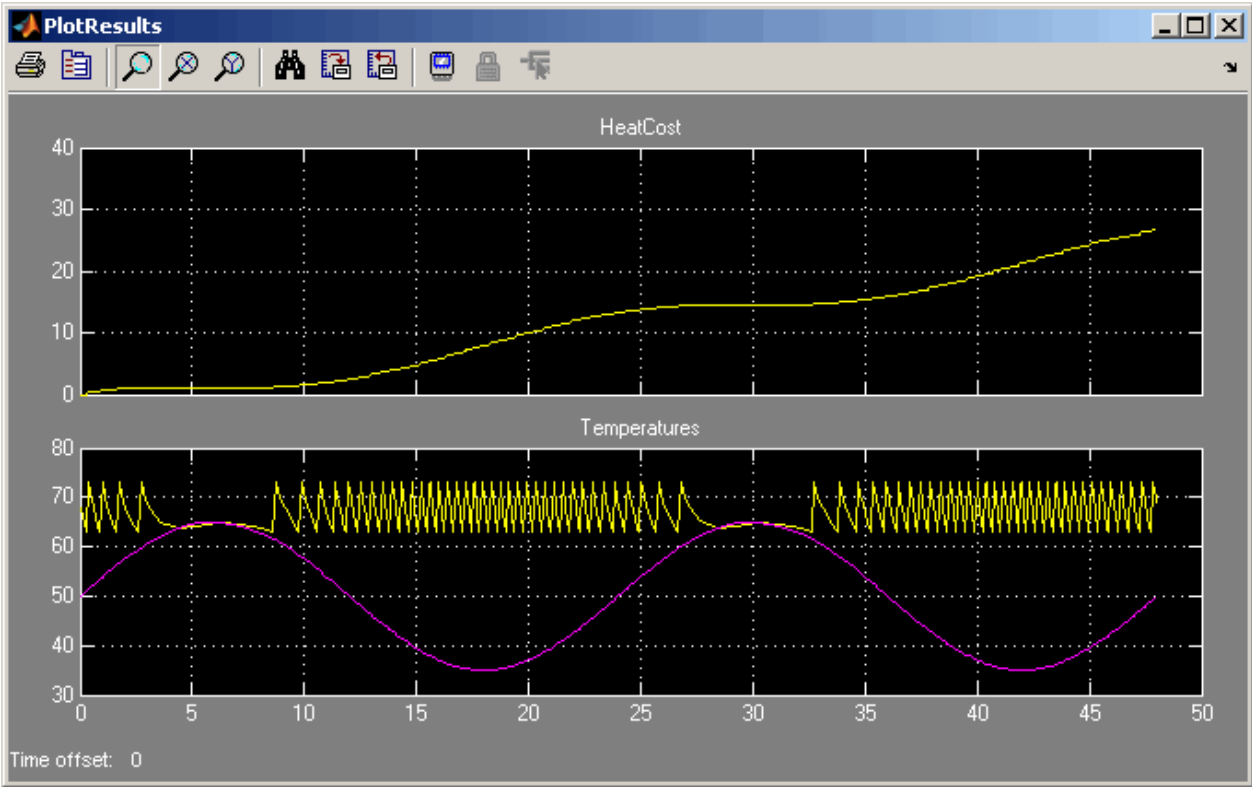

Changing the Average Outdoor Temperature

Change the average outdoor temperature to 45 degrees Fahrenheit and observe how the model responds.

To change the average outdoor temperature:

- 1 Double-click the Avg Outdoor Temp block.

The Source Block Parameters dialog box appears.

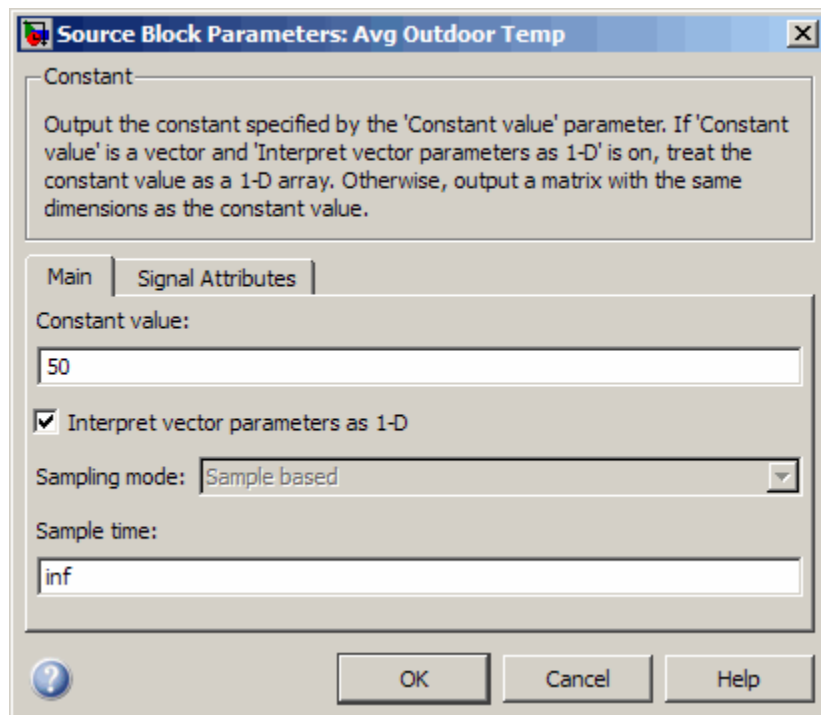

- 2 Enter 45 in the **Constant value** field.

- 3 Click **OK**.

The software applies your changes and closes the dialog box.

- 4 Select **Simulation > Start** to rerun the simulation.

The software simulates the model.

Notice that a colder outdoor temperature increases the cumulative heating cost.

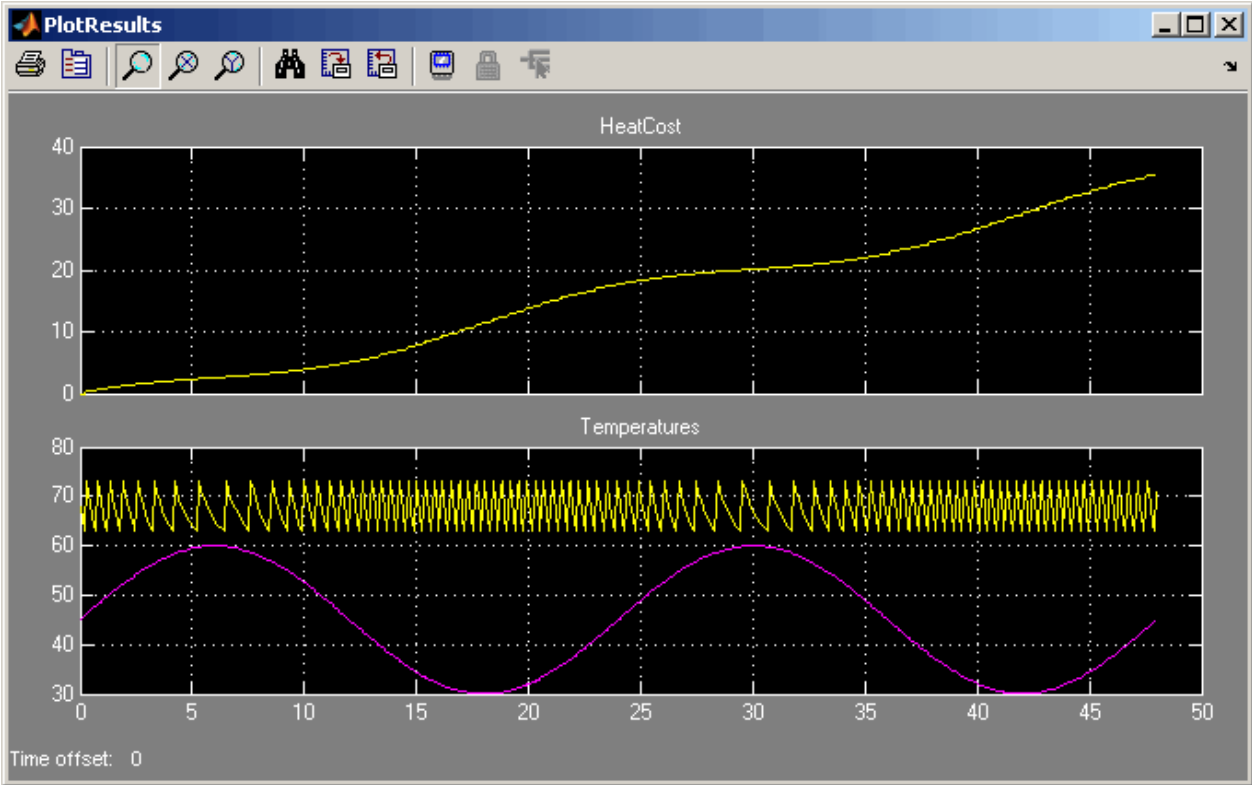

Changing the Daily Temperature Variation

Decrease the temperature variation to see how the model responds.

- 1 Double-click the Daily Temp Variation block.

The Source Block Parameters dialog box appears.

Source Block Parameters: Daily Temp Variation

Sine Wave

Output a sine wave:

$$O(t) = \text{Amp} * \sin(\text{Freq} * t + \text{Phase}) + \text{Bias}$$

Sine type determines the computational technique used. The parameters in the two types are related through:

Samples per period = $2 * \pi / (\text{Frequency} * \text{Sample time})$

Number of offset samples = $\text{Phase} * \text{Samples per period} / (2 * \pi)$

Use the sample-based sine type if numerical problems due to running for large times (e.g. overflow in absolute time) occur.

Parameters

Sine type: Time based

Time (t): Use simulation time

Amplitude: 15

Bias: 0

Frequency (rad/sec): $2 * \pi / 24$

Phase (rad): 0

Sample time: 0

Interpret vector parameters as 1-D

OK Cancel Help

- 2 Enter 5 in the **Amplitude** field.

3 Click **OK**.

The software applies your changes and closes the dialog box.

4 Select **Simulation > Start** to rerun the simulation.

The software simulates the model.

In the Scope window, notice that a more stable outdoor temperature alters the frequency with which the heater operates.

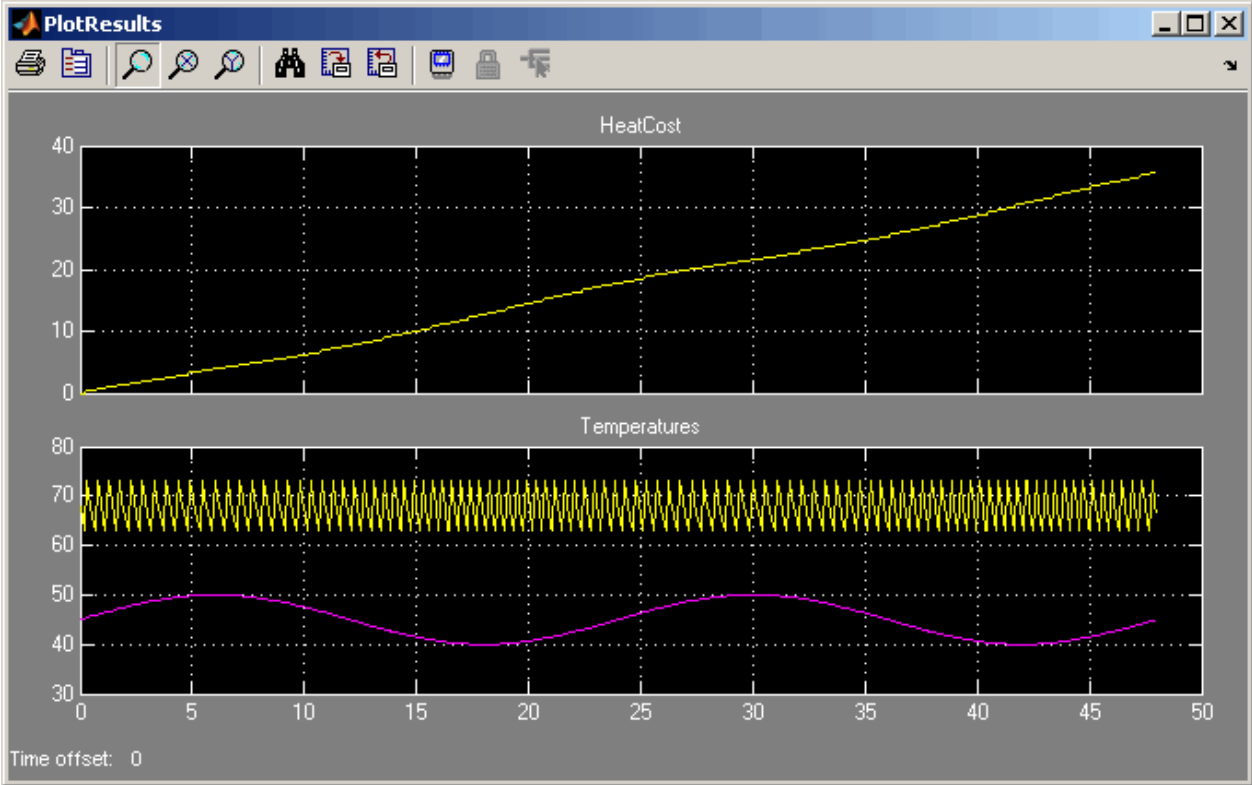

Importing Data from the MATLAB Workspace

Simulink also allows you to import data from the MATLAB workspace to the model's input ports. This allows you to import actual physical data into your model. (For information about other data import capabilities, see "Importing Data from a Workspace" in the Simulink User's Guide.)

Note In this example, you will create a vector of temperature data in MATLAB, and use that data as an input to the Simulink model.

To import data from the MATLAB workspace:

- 1 In the MATLAB Command Window, create time and temperature data by entering the following commands:

```
x = (0:0.01:4*pi)';  
y = 32 + (5*sin(x));  
z = linspace(0,48,1257)';
```

- 2 In the Simulink model window, select the Avg Outdoor Temp block, then press the **Delete** key to delete it.

- 3 Delete the following items from the model in the same way:

- Daily Temp Variation block
- Two input signal lines to the Sum block
- Sum block

The model should now look similar to the following figure. Notice that the output signal from the Sum block changes to a red, dotted line, indicating that it is not connected to a block.

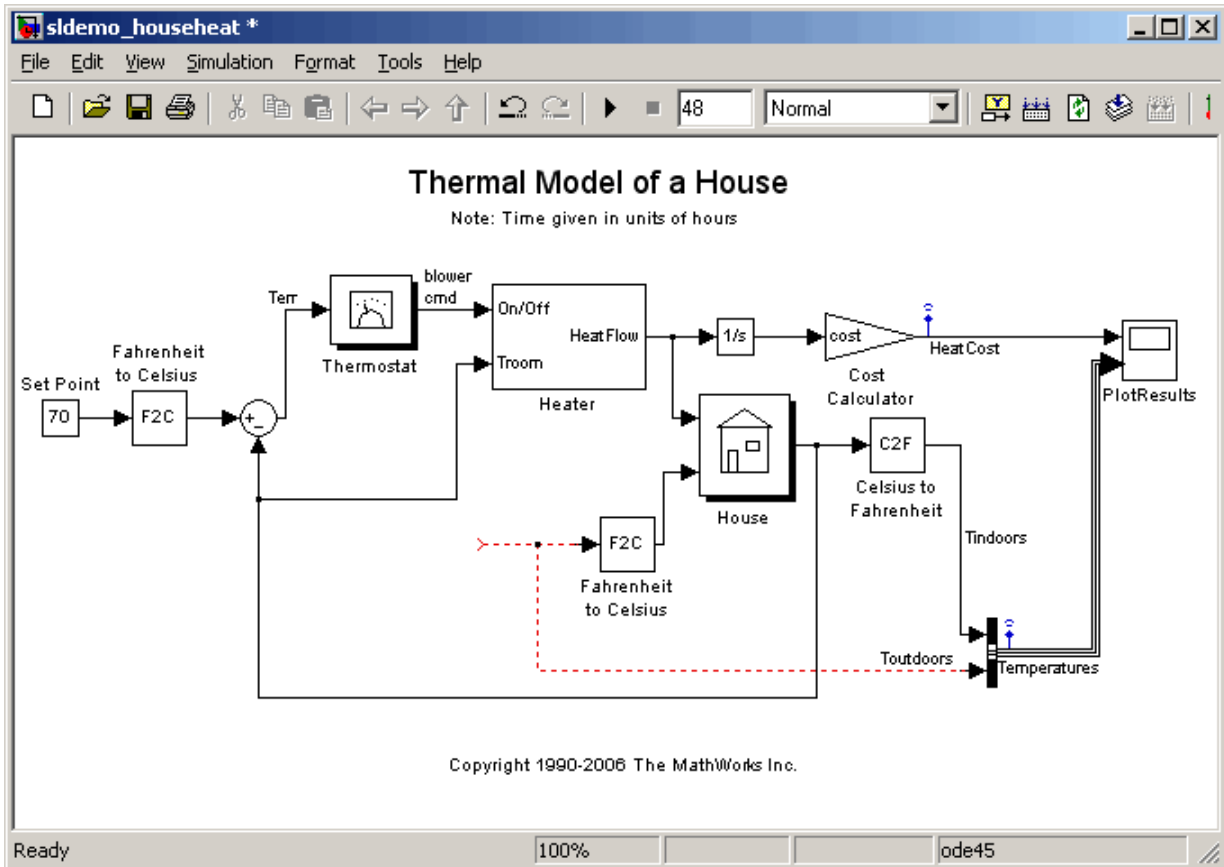

- 4 If the Simulink Library Browser is not open, select **View > Library Browser** in the model window to open it.
 - 5 Select the **Sources** library in the Simulink Library Browser.
 - 6 Select the **In1** block in the Simulink Library Browser, then drag it to the model window.
- An In1 block appears in the model window.
- 7 Connect the dotted line (originally connected to the Sum block) to the In1 block.

4 Modeling a Dynamic Control System

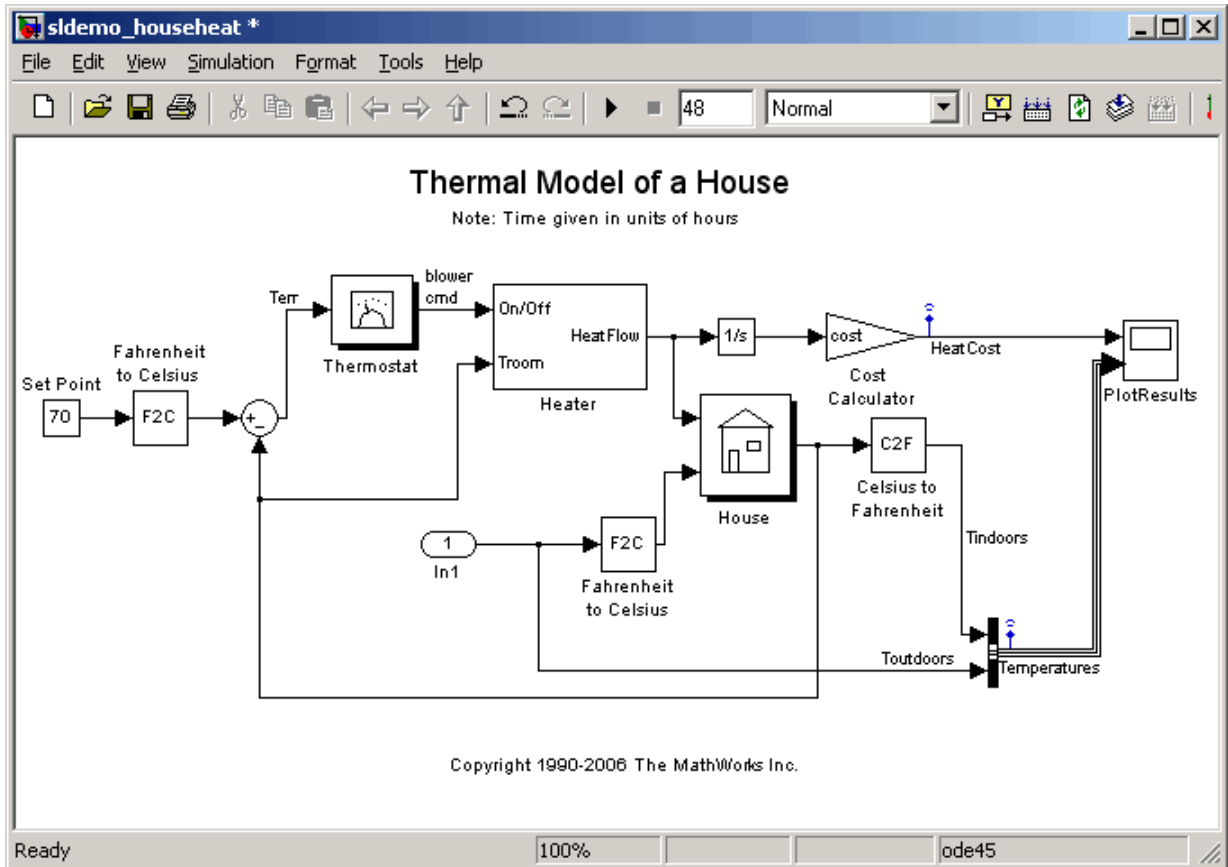

8 Select **Simulation > Configuration Parameters** in the model window.

The Configuration Parameters dialog box appears.

9 Select **Data Import/Export** in the menu on the left side of the dialog box.

The Data Import/Export pane appears.

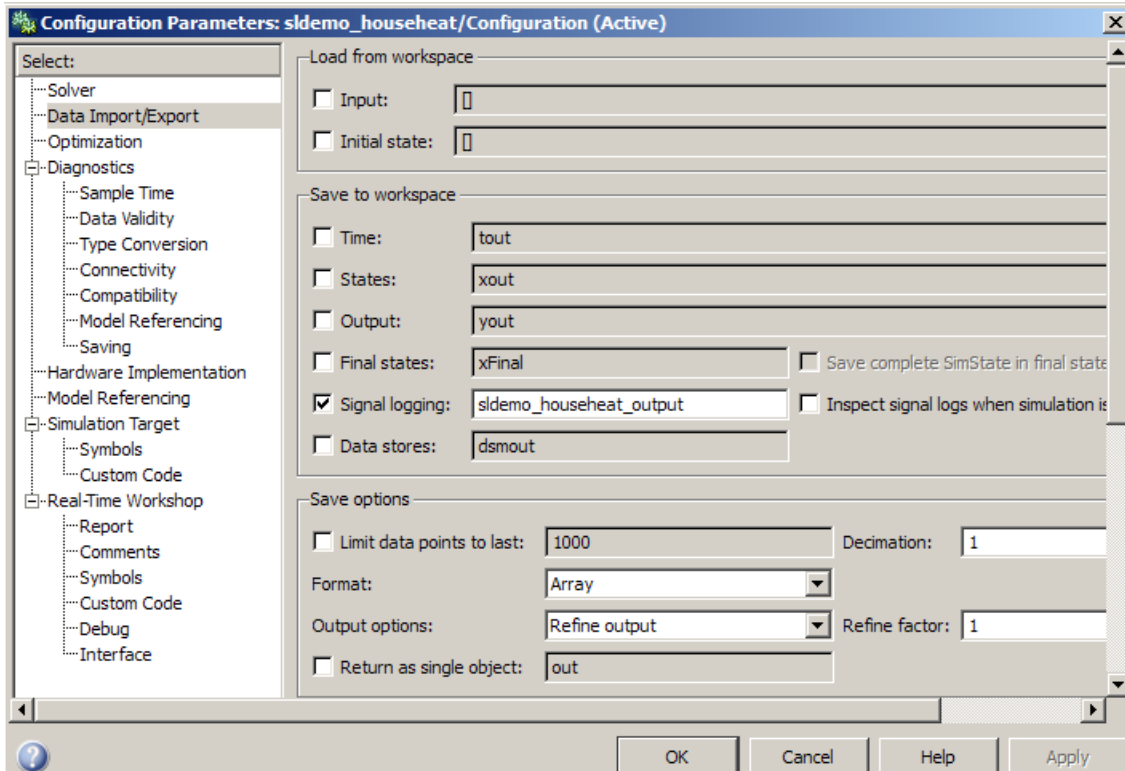

10 Select the **Input** check box in the Load from workspace section.

11 Enter [z, y] in the **Input** field.

12 Click **OK**.

The software applies your changes and closes the dialog box.

13 Select **Simulation > Start** to rerun the simulation.

The software simulates the model.

4 Modeling a Dynamic Control System

In the Scope window, notice that the model ran using the imported data, showing colder temperatures and higher heat use.

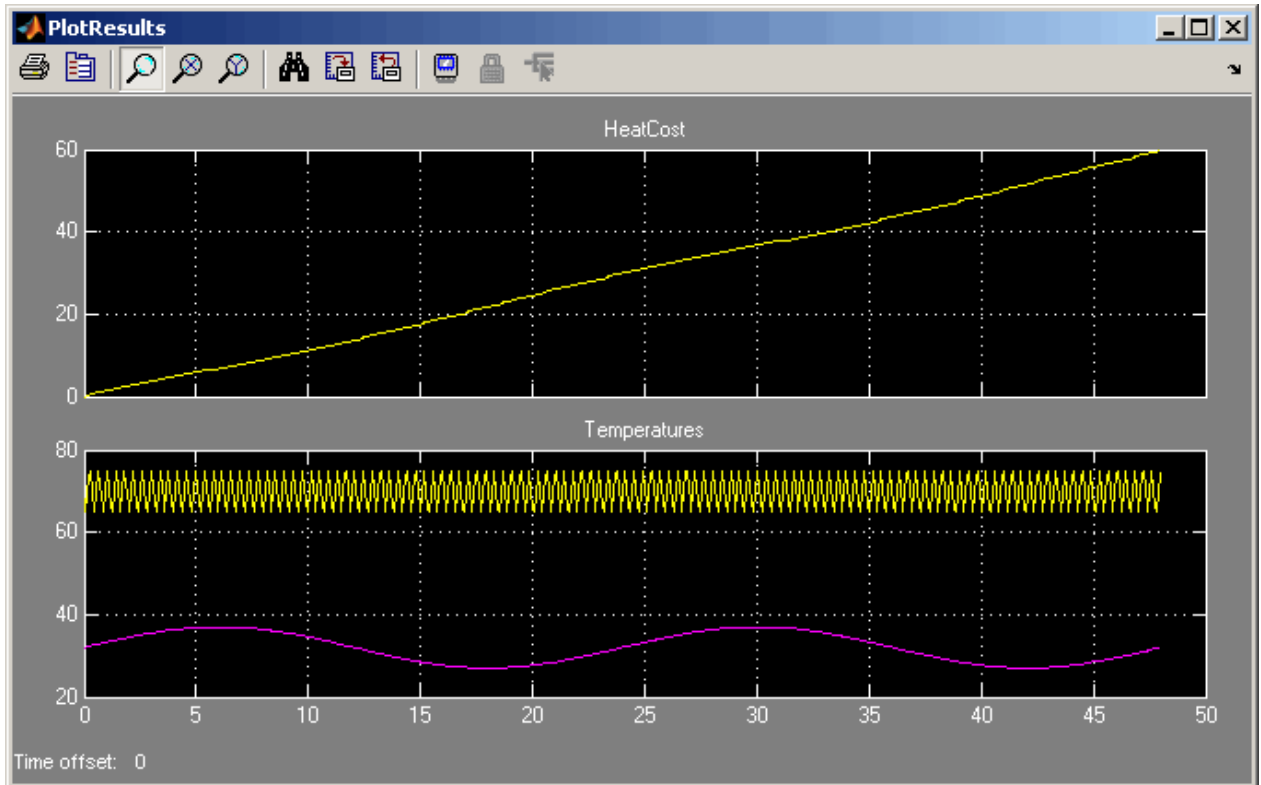

Exporting Simulation Data to the MATLAB Workspace

Once you have completed a model, you may want to export your simulation results to MATLAB for further data analysis or visualization. (See “Exporting Data to the MATLAB Base Workspace” for information about additional data export capabilities.)

To export the HeatCost data from the model to the MATLAB workspace:

- 1 Select the **Sinks** library in the Simulink Library Browser.
- 2 Select the **Out1** block in the Simulink Library Browser, then drag it to the top right of the model window.

An Out1 block appears in the model window.

- 3 Draw a *branch line* from the HeatCost signal line to the Out1 block. For more information, see “Drawing a Branch Line” on page 3-11.

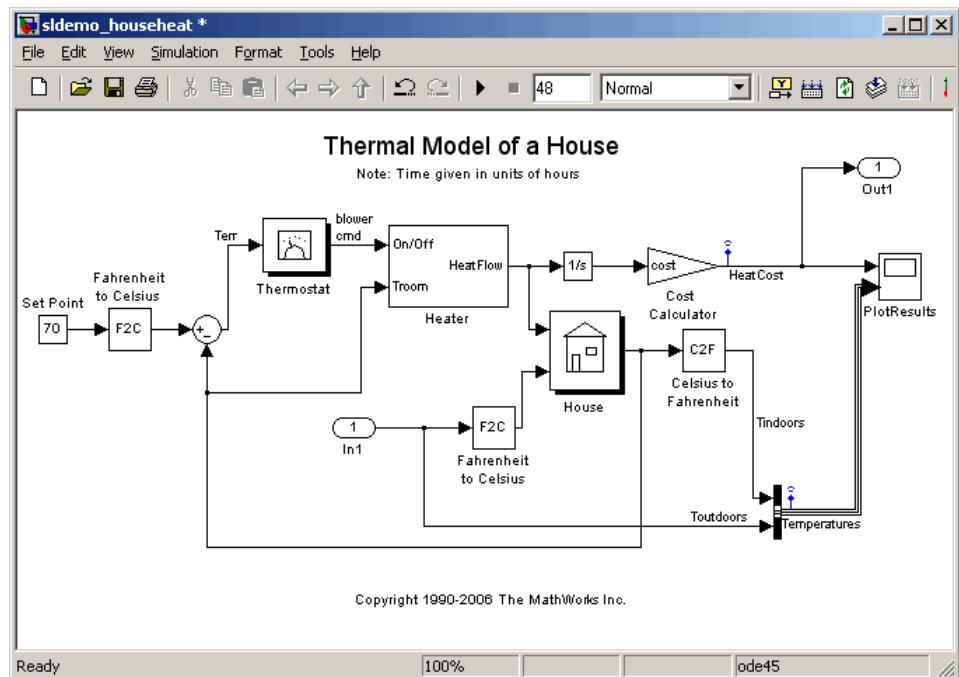

4 Select **Simulation > Configuration Parameters** in the model window.

The Configuration Parameters dialog box appears.

5 Select **Data Import/Export** in the menu on the left side of the dialog box.

The Data Import/Export pane appears.

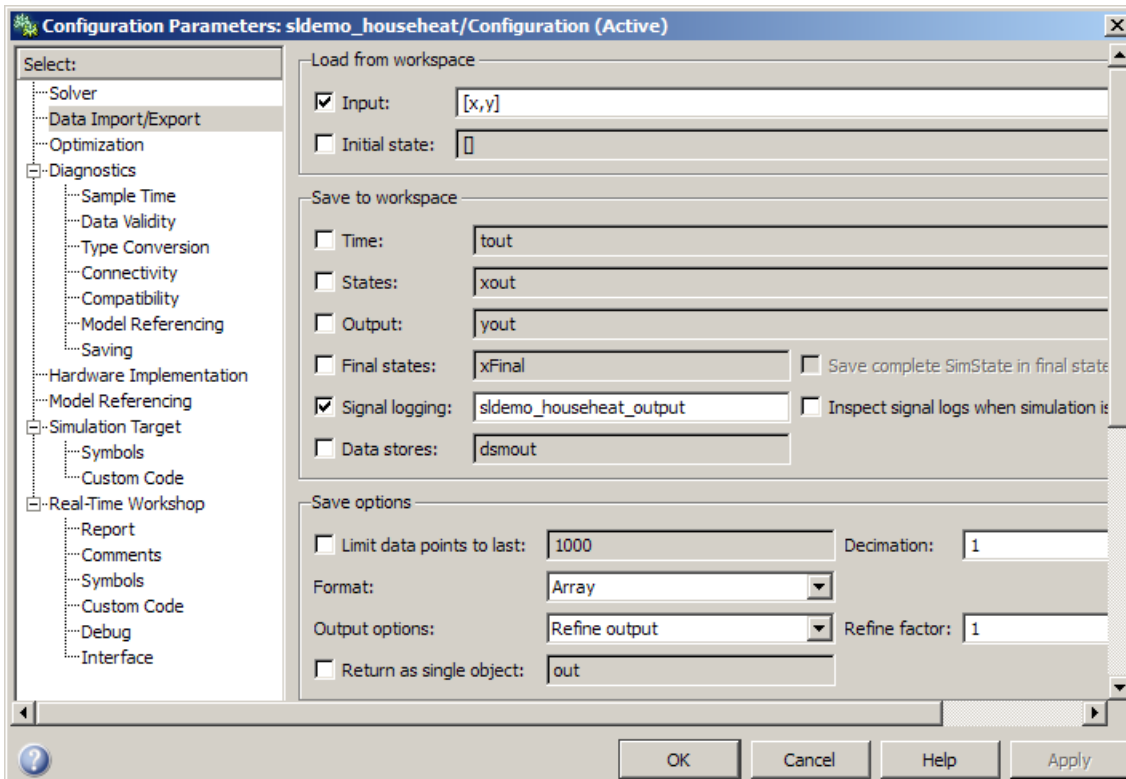

6 Select the **Time** check box in the Save to workspace section.

7 Select the **Output** check box in the Save to workspace section.

8 Click **OK**.

The software applies your changes and closes the dialog box.

- 9 Select **Simulation > Start** to rerun the simulation.

The software simulates the model and saves the time and HeatCost data to the MATLAB workspace.

Notice that the tout and yout variables now appear in the MATLAB workspace.

A

adding blocks to a model 3-5

B

basics

 Simulink 2-1

block libraries

 descriptions 2-7

blocks

 connecting 3-9

 copying 3-5

 masking 4-9

 moving 3-8

 ports 3-9

 subsystems 4-6

browser

 library 2-6

C

closing

 model 3-17

Configuration Parameters dialog box 3-14

connecting

 blocks 3-9

 lines to input ports 3-9

control system

 model overview 4-5

 modeling 4-2

copying blocks to a model 3-5

creating

 new model 2-4 3-3

 subsystem 4-8

 subsystem mask 4-10

D

data

 exporting to MATLAB 4-25

 importing from MATLAB 4-20

demo model

 opening 4-3

 overview 4-5

 running 4-11

demos

 accessing 2-11

E

example model 3-2

exporting

 data from Simulink to MATLAB 4-25

H

help

 Simulink 2-10

house model

 overview 4-5

I

importing

 MATLAB data to Simulink 4-20

input data

 importing from MATLAB 4-20

input port 3-9

L

library

 descriptions 2-7

 searching 2-7

 selecting 2-7

 viewing 2-7

Library Browser

 opening 2-2

 overview 2-6

 using 3-5

lines

- branching a signal 3-11
- carrying the same signal 3-9
- connecting to input ports 3-9

M

masking

- creating a mask 4-10
- overview 4-9

MATLAB

- exporting data from Simulink 4-25
- importing data to Simulink 4-20
- Simulink interaction 1-4

model window

- moving blocks 3-8
- overview 2-9

Model-Based Design

- overview 1-5
- process 1-6

modeling

- control system 4-2
- process 1-6

models

- closing 3-17
- control system example 4-5
- creating new 2-4
- creating simple 3-3
- empty 3-3
- opening 2-4
- opening existing 2-5
- saving 3-13
- simple example 3-2
- simulating 3-14

modifying

- simulation parameters 4-13

moving

- blocks in the model window 3-8

O

online help

- accessing 2-10
- Simulink 2-10

opening

- demo model 4-3
- existing model 2-5
- model 2-4
- Simulink 2-2

output data

- exporting to MATLAB 4-25

output port 3-9

overview

- demo model 4-5
- Simulink 1-2

P

parameters

- modifying 4-13

product overview 1-2

products

- related 1-9

R

related products 1-9

running

- demo model 4-11
- simulation 3-14
- Simulink 2-2

S

sample

- model 3-2

saving

- models 3-13

simulating models

- exercise 3-14

- simulation
 - modifying parameters 4-13
 - running 4-11
 - specifying options 3-14
 - starting 3-16
 - stopping 3-16
 - Simulink
 - basics 2-1
 - demos 2-11
 - getting help 2-10
 - Library Browser 2-6
 - MATLAB interaction 1-4
 - model window 2-9
 - online help 2-10
 - opening 2-2
 - overview 1-2
 - related products 1-9
 - starting 2-2
 - user interface 2-6
 - web resources 2-14
 - starting
 - MATLAB 2-2
 - simulation 3-16
 - Simulink 2-2
 - stopping
 - simulation 3-16
 - subsystems
 - creating 4-8
 - masking 4-9
 - overview 4-6
- T**
- thermo model
 - overview 4-5
- U**
- user interface
 - Simulink 2-6
- W**
- web resources
 - Simulink 2-14